

Installation guide



Video instructions
www.duco.tv

Table of contents

01 Introduction	3
02.C Air duct connections.....	4
02 Mounting	4
02.A Positioning.....	4
02.B Mounting.....	4
03 Regulations and safety instructions	5
04 Wiring	7
04.A Connector & buttons.....	7
04.B Wiring diagram.....	7
05 Additional control options	8
05.A Box sensors.....	8
05.B Duco Connectivity Board.....	9
06 Electrical installation	9
06.A Change settings.....	9
06.B Installer / User mode.....	9
06.C LED indications.....	10
06.D Pairing components.....	10
06.E Removing / replacing components.....	11
06.F Tips.....	11
07 Air calibration	12
07.A Calibration procedure DucoBox Silent Connect UK / IE.....	12
07.B Checking.....	13
08 Maintenance & service	14
09 Warranty	14
10 Legislation	14

Translation from Dutch of the original instructions

See www.duco.eu for information regarding warranty, maintenance, technical data, etc.

Installation, connection, maintenance and repairs are to be carried out by an accredited installer. The electronic components of this product may be live. Avoid contact with water.



01 Introduction

The DucoBox Silent Connect UK / IE performs two functions within a DUCO Demand-Controlled Natural Ventilation System:

On the one hand it is the **extractor fan** that exhausts stale air with excessive CO₂ content or humidity.

On the other it is the system '**master**' or brain of the system. It receives and interprets signals from slave components (measurements from sensors or manual input), on the basis of which it controls the ventilation system.

It is inadvisable to connect the DucoBox (via a duct or directly) to an extractor hood, regardless of type. This usually causes excessive fouling in the DucoBox, which affects its operation or has a more direct effect on the flow rate.

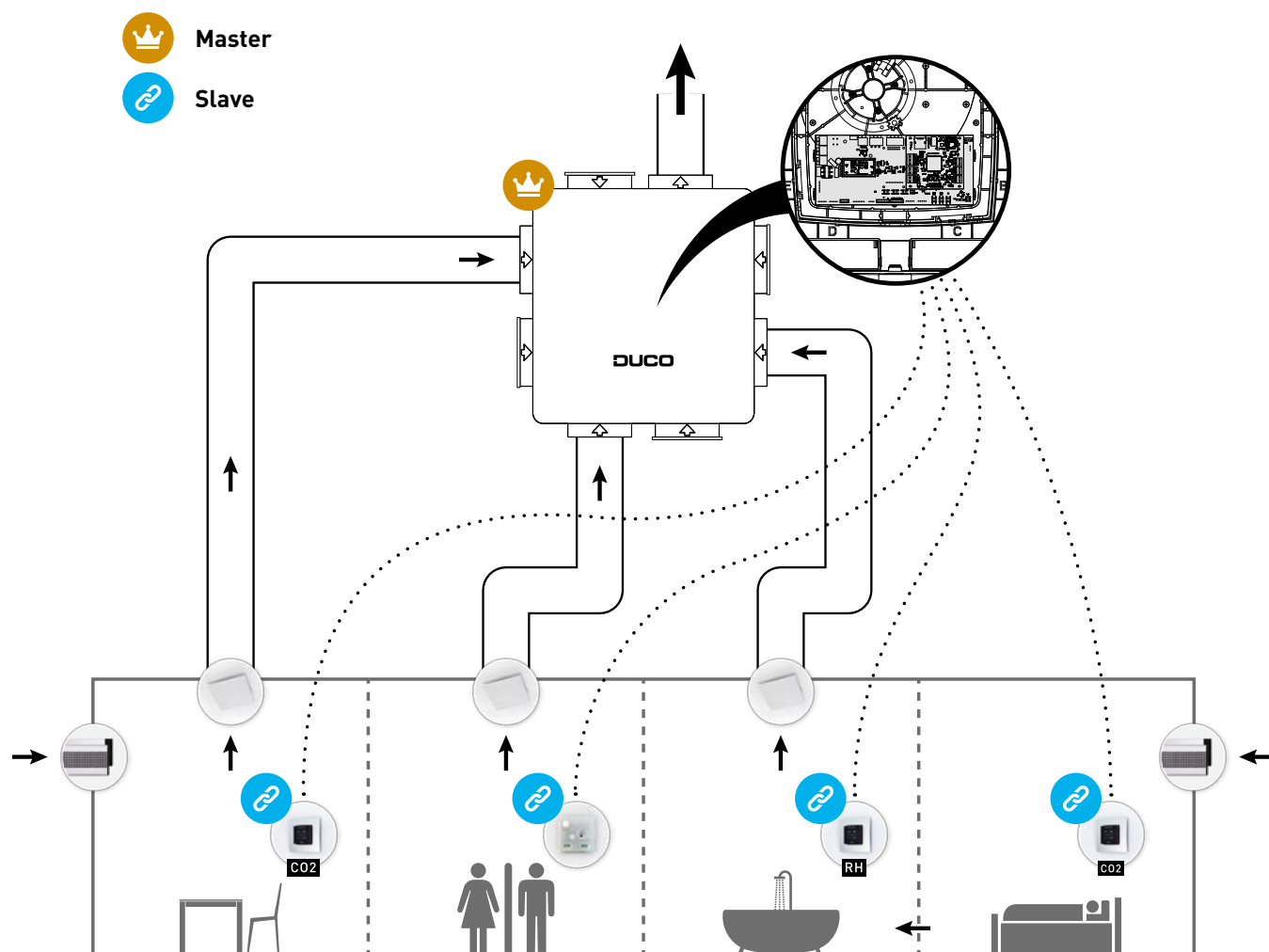

02 Mounting

02.A Positioning

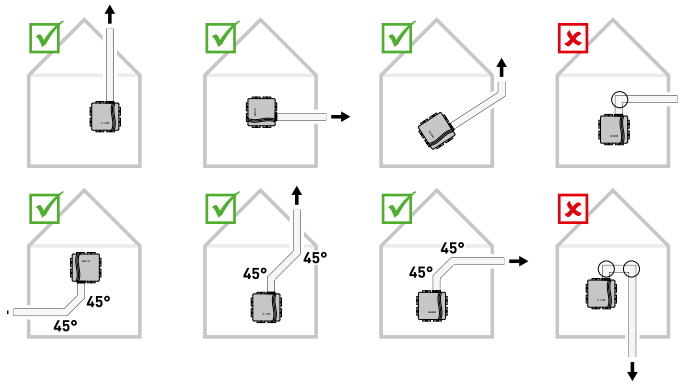

02.B Mounting

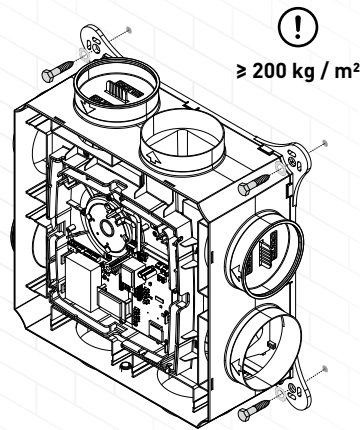

02.C Air duct connections

Keep down restriction. A non-return flap valve is required when discharging into a manifold. Position it at least 30 cm away from the DucoBox.

Be sure to take note of the '10 unmissable tips' as well when mounting the DucoBox. Avoiding excessive use of bends, especially angles equal to or sharper than 90° and adhering to the diameter guidelines for the ductwork will ensure that the ventilation box is able to do its job satisfactorily. Failure to take account of this recommendation may result in a highly energy and maintenance intensive system that gives rise to excessive noise nuisance frequently.

10 UNMISSABLE TIPS

The smooth running of your Duco ventilation system is totally dependent on the choice and the quality of implementation of the duct system!

Has the duct system been optimized? Ask professional advice from your duct supplier. It saves you time, ensures quality and provides energetic advantage for the end user!

DISCLAIMER: no rights can be derived from this document. All tips are only advisory. All those carrying out the work can, depending on the project at hand, determine for themselves which tips are feasible and/or useful.

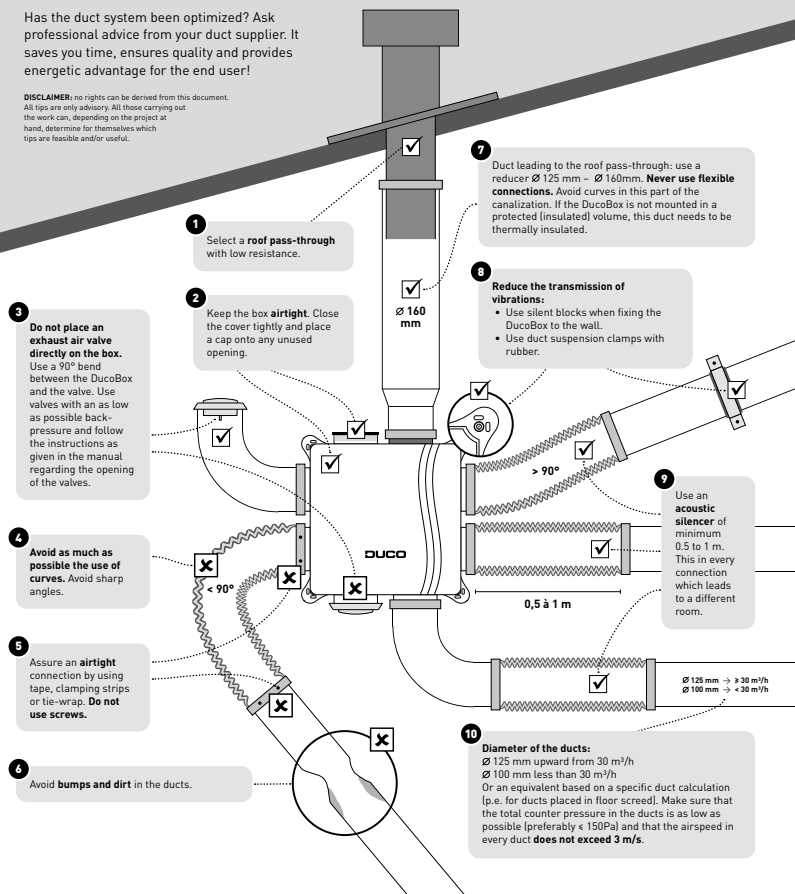

03 Regulations and safety instructions



The installer is responsible for installing and commissioning the unit.



Do not install this product in areas where the following are present or could occur:

- **Excessively greasy atmosphere.**
- **Corrosive or flammable gases, liquids or fumes.**
- **Room air temperature above 40 °C or below -5 °C.**
- **Relative humidity higher than 90% or outdoors.**
- **Obstacles that prevent access to or the removal of the fan unit.**
- **Bends in the ducts immediately upstream of the fan unit.**
- **The DucoBox Silent Connect UK / IE should not be connected to a (motorless) extractor hood or dryer.**

Take care to ensure that the electrical supply is a 230 V, single-phase earthed, 50/60 Hz, AC system. The device must be connected to an earthed and fused wall socket.

Preferably mount the unit in an enclosed space. The fan unit can only be used with the appropriate DUCO accessories and user controller(s). The installer must ensure that the fan unit is positioned at least 3 m away from a chimney pipe. The unit must not be used in locations where it could be subjected to direct water spraying. Certain situations may require the use of acoustic insulation materials.

Check that the unit is complete and undamaged when you take it out of the packaging. If in doubt about this, contact DUCO / your DUCO distribution point.

Electrical equipment should be handled with care.

- Never touch the unit with wet hands.
- Never touch the unit when barefoot.

Do not use the unit in the presence of flammable or volatile substances such as alcohol, insecticides, petrol etc.

Make sure that the electrical system to which the unit is connected, complies with the stipulated conditions. Do not expose the device to weather conditions. Do not place any objects on the unit.

Do not use the unit as an extractor for water heaters, heating systems, etc.

Ensure that the unit discharges into a single exhaust duct that is suitable and installed for the purpose and exhausts to the outside. Ensure that the electrical circuit is not damaged.

Always adhere to the safety instructions in the manual when installing the device. Failure to follow these safety instructions, warnings, notes and instructions may result in damage to the DucoBox Silent Connect UK / IE or personal injury and DUCO NV cannot be held responsible for this.

The installation of the DucoBox Silent Connect UK / IE should be carried out in accordance with the general and locally applicable building, safety and installation regulations of the municipality and other authorities.

Only an approved installer should install, connect and commission the DucoBox Silent Connect UK / IE as described in this manual.

Keep the manual close to your unit. Maintenance instructions must be followed closely in order to avoid damage and/or wear.

It is recommended that a maintenance contract be taken out to ensure the unit is regularly inspected and cleaned. The device must be fitted in a touch-safe manner. This means, among other things, that under normal operating conditions no-one can reach moving or electrically live parts of the fan without intending to do so for operations such as:

- Taking off the cover.
- Taking the motor module out of the fan after removing the cover.
- Disconnecting a duct or control valve from the connection opening during normal operation.

It ought to be impossible to touch the fan by hand. That is why ductwork must always be connected to the DucoBox Silent Connect UK / IE before putting it into operation. Therefore, at least 900 mm of ducting must be connected to the unit.

The DucoBox Silent Connect UK / IE meets the legal requirements for electrical appliances.

Always ensure that before work begins, the device is isolated from the power supply by removing the power cord from the wall socket or by switching off the fuse. (Use a measuring instrument to check that this is actually the case!)

Use suitable / appropriate tools to work on the unit.

Use the unit only for applications for which it has been designed, as stated in this manual.

The ventilation unit should operate permanently, i.e. the DucoBox Silent Connect UK / IE should never be switched off (legal requirement).

The electronic components of the ventilation unit may be live. In the event of a fault, contact a professional installer and have repairs carried out only by qualified personnel.

This unit is not intended for use by people (including children) with reduced physical, sensory or mental capabilities, or who lack experience of know-how, unless they are supervised or have been given instructions on the use of the unit by a person who is responsible for their safety. Children must be supervised to ensure that they do not play with the unit.

If the power cord is damaged, it must be replaced by the manufacturer, after-sales support or individuals with comparable qualifications in order to prevent any hazard.

The user is responsible for safely removing the ventilation unit at the end of its service life, in accordance with locally applicable laws or regulations. You can also take the unit to a collection point for used electrical equipment.

The unit is only suitable for housing construction and not for industrial use, such as swimming pools and saunas.

When handling electronics, always take ESD¹ inhibiting measures, such as wearing a grounded wristband.

Modifications to the unit or to specifications stated in this document are not permitted.

Do not pull on the cord to remove the plug from the socket.

Always consult the installer of your combustion appliance to establish whether there is any risk of flue gases entering the home.

Check that the voltage shown on the type plate matches the local mains voltage before connecting the device. You will find the type plate inside the box.

1 ESD = electrostatic discharge

04 Wiring

04.A Connector & buttons

Strain relief

It is mandatory to place the power supply cable in the slot provided, as shown in the drawing, before powering up the DucoBox.

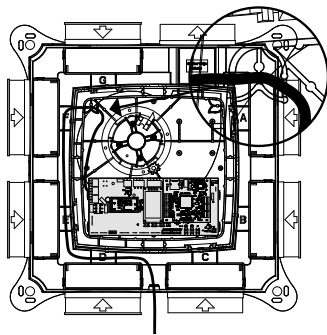

Illustrations and connections may vary depending on the version of the product. Incorrect connection or failure to follow the instructions may result in damage to the connected devices.

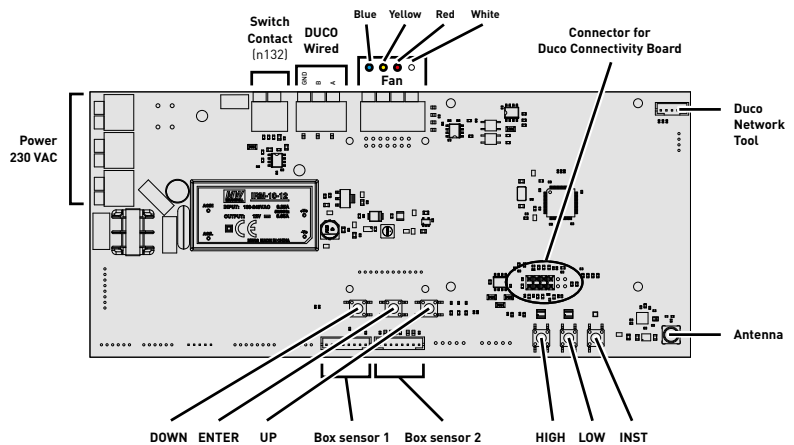

04.B Wiring diagram

The DucoBox Silent Connect UK / IE can communicate with DUCO 'slave' components via either a wireless (RF) or wired (Wired) connection. Both types of communication can be combined in one system. Communication with non-DUCO components is possible via the switch sensor.

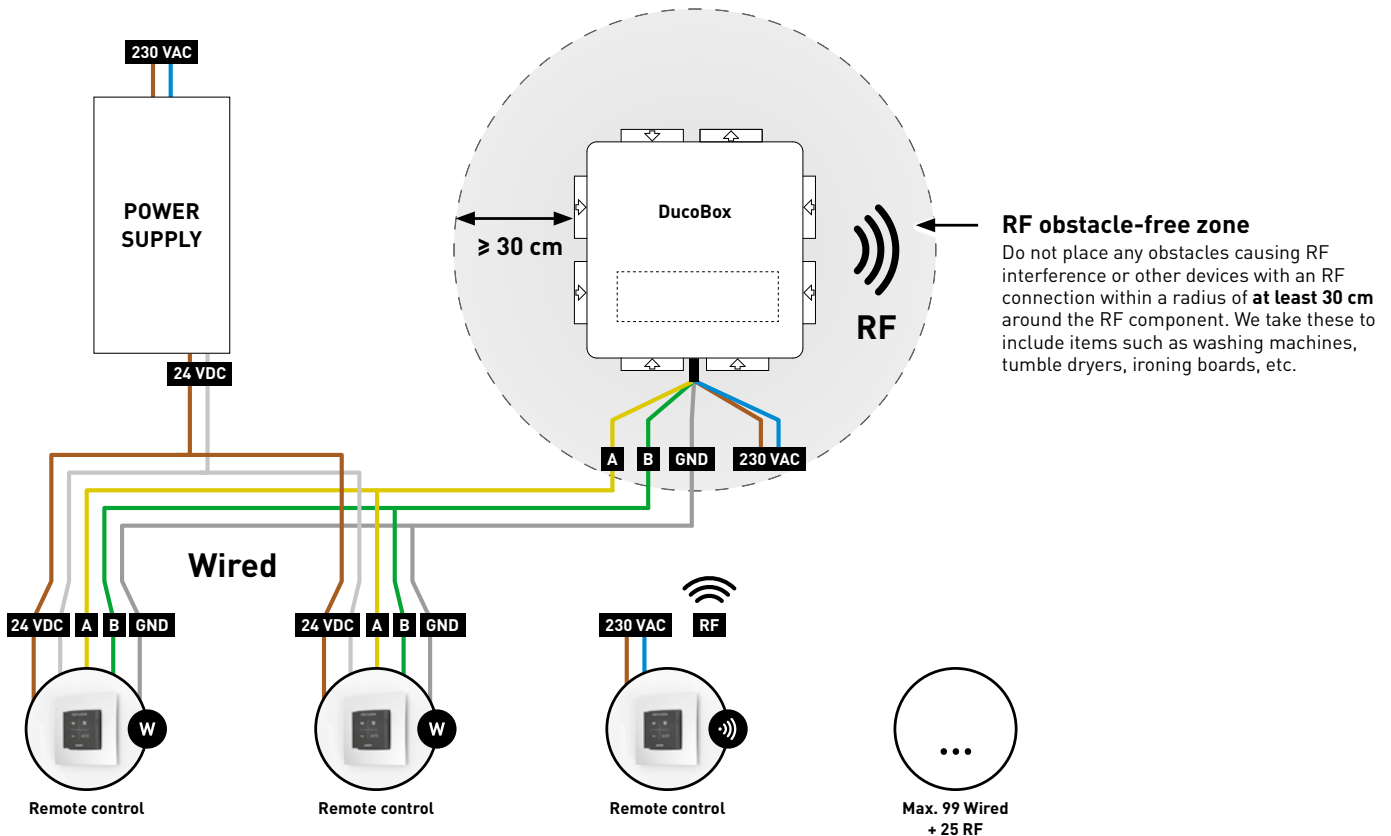

RF (wireless communication)

RF components have a maximum free-field range of 350 metres. This distance will be much less in a building because of obstacles. Therefore, you will need to take objects such as walls, concrete and metal into account. All slave components (except those which are battery powered) also act as repeaters. Signals from components that are unable to make a (strong) connection with the master component are forwarded automatically via no more than one other non-battery-powered component (= hop). Please refer to information sheet **RF communication [L8000018]** at www.duco.eu for further information.

DUCO RF	
Power Supply	230 VAC
Wiring	1,5 mm ²
Frequency	868 Mhz
Maximum distance	350 m, free field (less through obstacles)
Maximum number of components	Up to 25 wireless components in a single system

Wired (cabled communication)

Wired components can be daisy-chained (= recommended). This means that a separate cable will not be required for each component. A single central power supply can be used.

The cable required is a 5 x 0.75 mm² data cable. To avoid interference with data communication, we strongly recommend using a shielded cable.

DUCO WIRED	
Power Supply	24 VDC
Wiring	5 x 0,75 mm ²
Maximum distance	up to 300 m
Maximum number of components	Up to 99 wired components in a single system

05 Additional control options

05.A Box sensors

Box sensors can be integrated into a DucoBox Silent Connect UK / IE and provide CO₂ and/or moisture measurement in an air duct. A DucoBox Silent Connect UK / IE can contain **a maximum of one CO₂ Box sensor and one Humidity Box Sensor**. If the living room (CO₂ measurement) and bathroom (humidity measurement) are connected to the same duct/zone, the two Box Sensors can be clipped together.

Fitting + connecting Box Sensor

- 1 Twist the Box Sensor(s) into the desired duct in the box until the Box Sensor clicks into place.
- 2 Connect the Box Sensors to one of the two connectors provided on the DucoBox Silent Connect PCB.

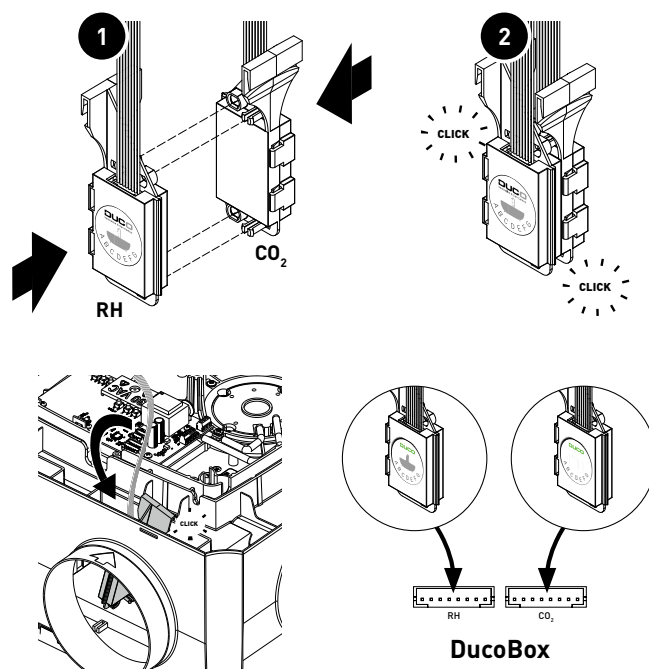

Settings

The CO₂ and RH setpoint can be changed via the Duco Installation App. See www.duco.eu for more information.

05.B Duco Connectivity Board

The optional circuit board allows linking towards home automation and building management systems via REST API (locally or via the cloud) or Modbus TCP (locally). Both are possible via Ethernet or Wi-Fi.

The Duco Connectivity Board also enables the Duco Installation App to be used. This application supports - and relieves - installers to control and maintain a ventilation system in a user-friendly way.

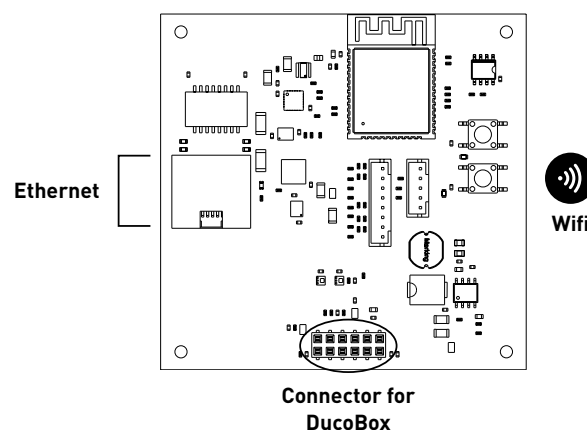

06 Electrical installation

06.A Change settings

Most of the factory settings for the network and components will be satisfactory as they are, however, depending on the situation, it may be desirable to change some parameters, such as the CO₂ setpoint. This can be done via the **Duco Installation App**. For more information, consult our website, scan the QR code or contact your DUCO distributor.

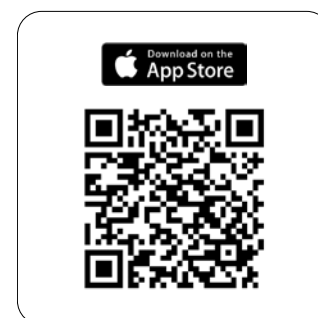







06.B Installer / User mode

To add, remove or replace components to the network, the system should be put in 'Installer mode'. The LED on each component indicates the component's active mode (see table in the next section).

'Installer mode' can be activated by pressing the 'INST' button on the DucoBox Silent Connect UK / IE (see drawing on page 7). Once the LED on the master unit starts flashing, it means that 'Installer mode' is active. Press 'INST' again to return to 'User mode' (LED fully on or off). The system reverts automatically to 'User mode' after 15 minutes of inactivity.

06.C LED indications

	RED (blinking slowly) Not in network	RED (blinking rapidly) Currently pairing
	GREEN (blinking slowly) In network	GREEN (blinking rapidly) In network, waiting for associated components
	YELLOW (blinking slowly) Transitional phase (please wait)	YELLOW (on) Initialising (system configuration in progress)
	WHITE or OFF Normal	
	BLUE Component is displayed if changes are being put through via the master.	
	ORANGE The system is not working correctly because the DucoBox has not been calibrated. Restart the DucoBox. Follow the guidelines in '10 essential tips' if the problem recurs continually.	

06.D Pairing components



Never pair more than one system with RF components at the same time. If you do so, a component could be paired to the wrong network, (e.g. the neighbours' DucoBox).

Pairing components

- 1** Activate 'Installer mode' by tapping **'INST'** on the DucoBox. The LED will flash green rapidly.
Add control components by **tapping once on the component to be paired**. The LED will flash red briefly and then start to flash green rapidly. Repeat this step until all remaining components in the current zone have been paired.
- 2** With RF components: start with the component closest to the master. If the first pairing is unsuccessful, another component may be tried first, which can then act as a hop for components that are unable to make an RF connection with the DucoBox.
- 3** Once all components have been paired, 'Installer mode' can be deactivated by tapping **'INST'** on the DucoBox. The LEDs on all components will stop flashing.

Example of a pairing sequence

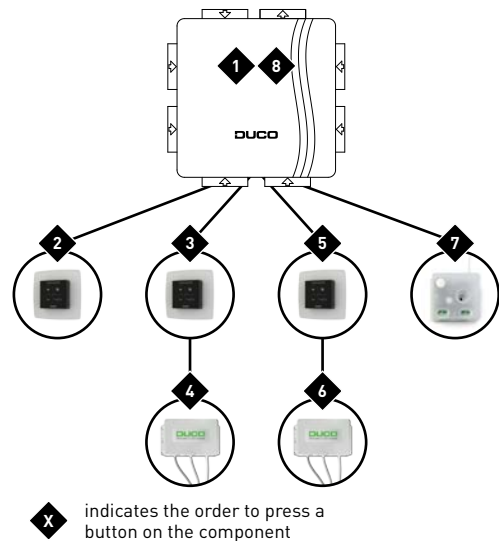

Please refer to the manual with the components for more detailed information.

06.E Removing / replacing components

Removing paired components from the network or replacing is **only possible within 30 minutes after the component is paired in or is restarted**. Restarting can be done by disconnecting the power for a moment. After a time-span of 30 minutes, remove and replace operations are ignored.

Removing a component

1

Activate 'Installer mode' by **long-pressing 2 diagonal buttons on a paired control**. The LED will flash green rapidly.

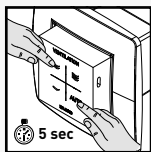

2

Press **once and hold** a button on the component to be removed in order to remove it from the network. **ATTENTION:** any underlying components will also be removed from the network.

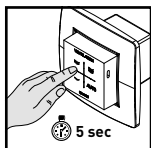

3

Deactivate 'Installer mode' by pressing the 4 buttons on a **paired control** simultaneously (or using the palm of your hand on a control featuring touch buttons). The LED will turn white.

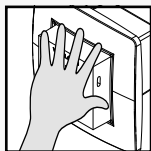

Replacing a component

1

Activate 'Installer mode' by **long-pressing 2 diagonal buttons on a paired control**. The LED will flash green rapidly.

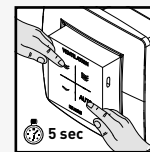

2

Briefly press **twice** on the button of the component to be replaced.

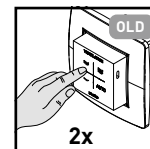

3

Tap once on the button of the new component. The latter will take on all settings / connections in the network.

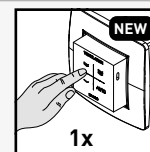

3

Deactivate 'Installer mode' by pressing the 4 buttons on a **paired control** simultaneously (or using the palm of your hand on a control featuring touch buttons). The LED will turn white.

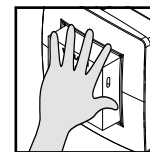

06.F Tips

- **Removing all components from the network (e.g. in the event of problems):** Activate 'Installer mode' and long-press 'INST' until the LED starts flashing red. The DucoBox will reboot (around 15 seconds) and the LED will stop flashing.
- **Restore factory settings for the DucoBox and all paired components:** Long-press 'INST' and 'ENTER' if not in 'Installer mode'. The network will be preserved.
- Use the **Duco Installation App** to read out information from components.

07 Air calibration

For the system to operate correctly, the air volume must be adjusted. This will ensure its operation is as quiet as possible and energy-efficient. For information on determining the ventilation flow rates, see Instruction Sheet Checking Product References and Flow Rates at www.duco.eu.

07.A Calibration procedure DucoBox Silent Connect UK / IE



The air calibration procedure must be carried out on a calm day (no more than wind force 2: leaves rustling, feeling the wind in one's face).

Adjusting DucoBox Silent Connect UK / IE

Set all exhaust vents so they match the desired flow rate in accordance with the table below. Proper pre-setting makes for rapid and correct calibration.

1

Flow rate	DucoVent Design	DucoVent Comfort	DucoVent Basic and other vents
70 m ³ /h		Position 0	100% open
50 m ³ /h		Position 3	50% open
20 m ³ /h		Position 7	25% open

When using DucoVent Design exhaust vents always leave the outer ring in place for acoustic effect.

Example

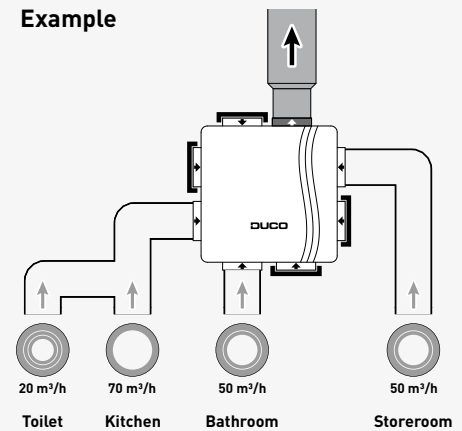

2

Before activating air calibration mode:

- Close **all** windows and doors.
- Ensure that **all duct openings in the DucoBox are fully closed and that the DucoBox lid is closed!**
- Avoid air leaks in the ventilation ducts.
- Set all window ventilators to the open position.

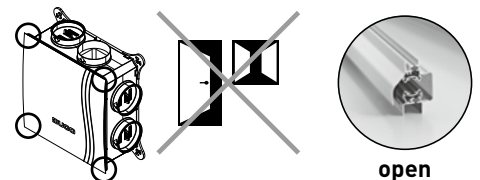

3

The DucoBox Silent Connect UK / IE has 4 modes: everyday speed (trickle rate), high speed (boost rate) or extra-high speed (purge rate) and AUTO mode. By default, these are set as follows:

- **Trickle rate:** 50% of maximum power (400 m³/h)
- **Boost rate:** 60% of maximum power
- **Purge rate:** 70% of maximum power
- **AUTO:** adjusted rate between trickle rate and boost rate based on moisture and/or CO₂ measurements

The boost and purge rate automatically evolve with the adjusted trickle rate, and remain respectively at 10 and 20% more than the trickle rate. The trickle rate can be adjusted in two ways, either on the box itself (standard method) or - alternatively - via a remote control in a specific room.

On the box itself

1. Remove the lid from the box and press the LOW button to activate the trickle rate. The trickle rate is set to 50% by default and you will see the LED flash 5 times. By pressing < or > you decrease or increase the percentage. After adjustment, the LED above the INST button will flash 4 x at 40% or 6 x at 60%.
2. Press Enter (■) to confirm the desired trickle rate percentage.
3. To adjust the boost rate, press the HIGH button. Afterwards, you can similarly decrease the percentage (<) or increase (>) and confirm with Enter (■).
4. Optionally - if desired - you can adjust the purge rate by pressing LOW and HIGH simultaneously. Then proceed as in step 3.



Note: if you decide to adjust the boost rate, there is no longer a link to the trickle rate (no more 10% difference). The same principle applies when adjusting the purge rate: the 10% rule no longer applies.

You can always restore the factory settings as follows: activate the adjustment mode by briefly pressing the LOW or HIGH button. Then press the INST, < and > buttons simultaneously. This restores the trickle rate to 50%, the boost rate to 60% and the purge rate to 70%.

You can confirm the calibration of a curve not only by pressing Enter (■), but this is also done automatically by activating a subsequent curve (boost rate or purge rate).

3

Alternative calibration via remote control:

1. Remove the lid from the box and press the LOW button to activate the trickle rate. The trickle rate is set to 50% and you will see the LED flash 5 times.
2. Now go to a room in the house where there is a remote control and measure the ventilation rate with a flow meter.
3. Adjust the flow rate on the remote control: press  once to reduce the trickle rate by 10% (and repeat if required) or press  once to increase the trickle rate by 10%.
4. Long press  to confirm the flow rate.

When using an RH Box sensor it is possible to change the relative humidity threshold, so that when the humidity is higher than the default value of 60%, the box will speed up from trickle rate to boost rate.

To do this, proceed as follows:



4

1. Make sure the LED above the INST button light up white.
2. Long press the buttons <, > and Enter (■) until the LED above the INST button flashes blue several times.
3. By default, the LED flashes 6 times, corresponding to a threshold value of 60% relative humidity.
4. By then pressing the >-button, you increase the threshold value by 10% (up to max. 90%).
5. By pressing the <-button, you decrease the threshold value by 10% (to min. 30%).
6. Confirm with Enter (■).

07.B Checking

The steps set out below can be used to check whether flow rates have been set correctly.

Checking configured flow rate

1. Open the lid of the DucoBox.
2. Select the desired curve, by briefly pressing LOW (trickle rate), HIGH (boost rate) or LOW and HIGH at the same time (purge rate). The DucoBox will remain in this curve for 30 minutes (by default).
3. Close the lid.
4. Measure the vents. If a flow rate differs from the desired flow rate, it can be adjusted via the box (< / >) or via the remote control ( or ).
5. When you are ready, open the lid of the DucoBox again and press Enter (■). Then replace the lid on the DucoBox.

08 Maintenance & service

Please refer to the maintenance instructions at www.duco.eu and view the videos on duco.tv for more information.

For service problems as a user:

Please contact your installer. Keep the serial number of your product to hand.

For service problems as an installer:

Please contact your retailer of DUCO products. Keep the serial number of your product to hand.

	
Volume: 400 m ³ /h	Type: DucoBox Silent Connect
Pressure: 150 Pa	Artnr.: S0004217
P max.: 84 W	Duco NV Handelsstraat 19 8630 Veurne Belgium +32 58 33 00 33
U nom.: 230VAC- 50Hz	
cos φ 0.55	
1536504-151119-081 	

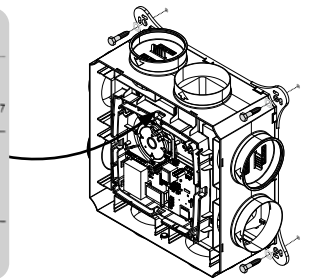

Sticker inside the DucoBox

09 Warranty

All warranty conditions concerning the DucoBox and DUCO's ventilation systems can be found on the DUCO website.

All complaints are to be reported to DUCO by the DUCO distributor with a clear description and the order/invoice number under which the products were delivered. To do so, please fill out the complaint registration form, found on the DUCO website, mentioning the serial number and send it to service@duco.eu.

10 Legislation

Product card, EC declaration of conformity and energy labels can be viewed and downloaded at www.duco.eu.

Installed by:

DUCO