

DucoBox Silent

ENGLISH **en**

Product version 17xxxx and above

Installation manual



Video instructions
www.duco.tv

Table of contents

01	Introduction	3
02	Regulations and safety instructions	4
03	Mounting	5
	03.A Position.....	5
	03.B Fixing.....	5
	03.C Air duct connections.....	5
04	Wiring	6
	04.A Connections & buttons.....	6
	04.B Wiring diagram.....	6
05	Additional control options	7
	05.A 3-position switch* via Perilex.....	7
	05.B Boxsensors.....	7
06	Electronical installation	8
	06.A Changing settings.....	8
	06.B Installer / User mode.....	8
	06.C LED indications.....	8
	06.D Setting type of home.....	9
	06.E Removing / replacing components.....	10
	06.F Tips.....	10
07	Air calibration	11
	07.A Air calibration procedure for DucoBox Silent.....	11
	07.B Checking.....	13
08	Maintenance & service	13
09	Warranty	14
10	Legislation	14

Translation of the original instructions

See www.duco.eu for information regarding warranty, maintenance, technical data, etc.

Installation, connection, maintenance and repairs are to be carried out by an accredited installer. The electronic components of this product may be live. Avoid contact with water.



Vero Duco - Handelsstraat 19 - 8630 Veurne - Belgium
 tel +32 58 33 00 33 - fax +32 58 33 00 44 - info@duco.eu - www.duco.eu



01 Introduction

Congratulations on your DucoBox Silent, the quietest box in Europe! The DucoBox Silent performs two functions in a DUCO Demand-Controlled Natural Ventilation System:

On the one hand it is the **extractor fan** that exhausts stale air with excessive CO₂ content or humidity.

On the other hand, it is the **controller**, or brain of the system. It receives and interprets signals from components (measurements from sensors or manual input), on the basis of which it controls the ventilation system.

It is inadvisable to connect the DucoBox (via a duct or directly) to an extractor hood, regardless of type. This usually causes excessive fouling in the DucoBox, which affects its operation or has a more direct effect on the flow rate.

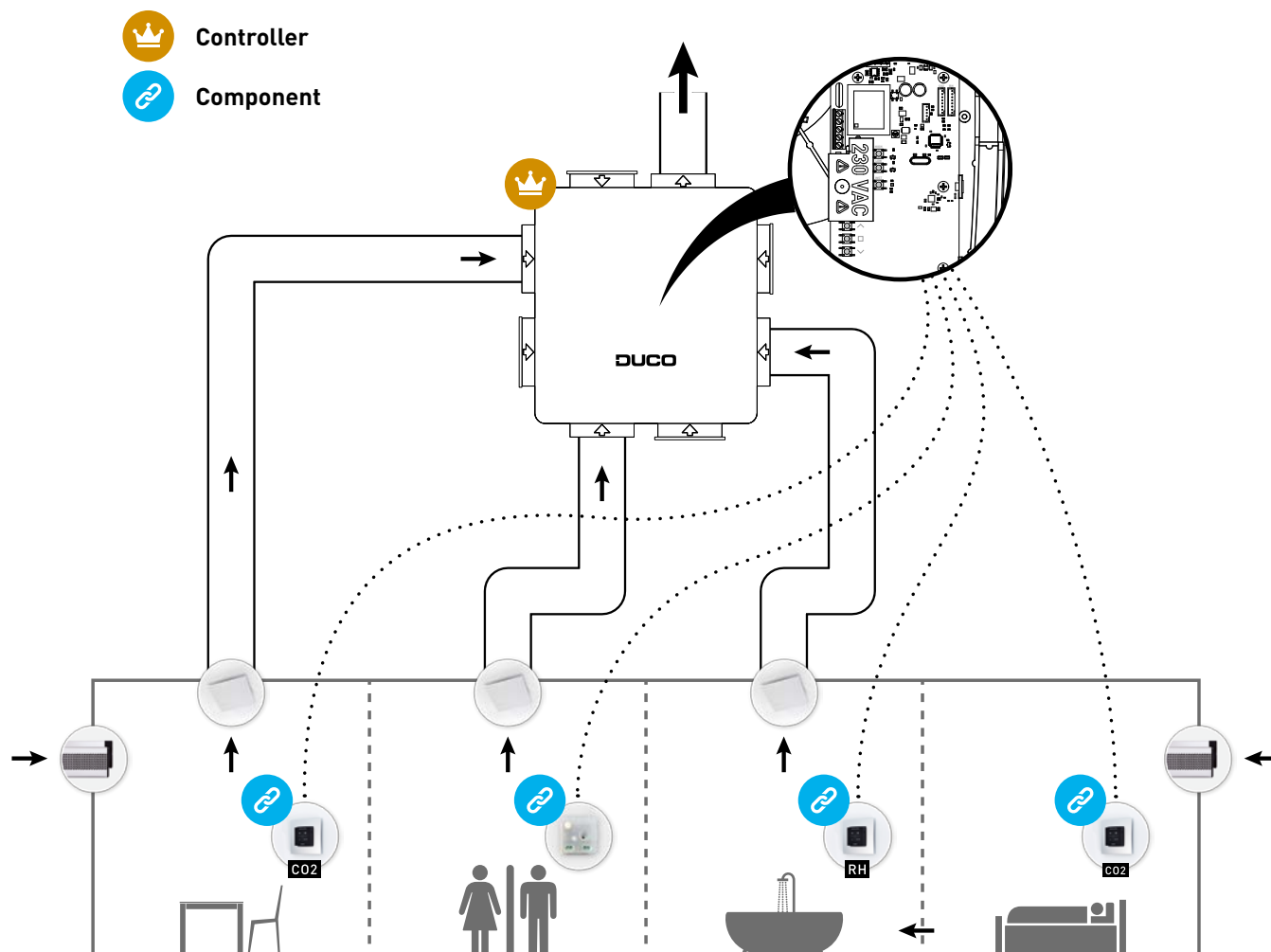

02 Regulations and safety instructions



The installer is responsible for installing and commissioning the unit.



Do not install this product in areas where the following are present or could occur:

- Excessively greasy atmosphere.
- Corrosive or flammable gases, liquids or fumes.
- Room air temperature above 40 °C or below -5 °C.
- Relative humidity higher than 90 % or outdoors.
- Obstacles that prevent access to or the removal of the fan unit.
- Bends in the ducts immediately upstream of the fan unit.
- The DucoBox Silent must not be connected to a (motorless) extractor hood or tumble dryer.

Take care to ensure that the electrical power supply is a 230 V, single-phase earthed, 50/60 Hz, AC system. The device must be connected to an earthed and fused wall socket. Preferably mount the unit in an enclosed space. The fan unit can only be used with the appropriate DUCO accessories and user controller(s). The installer must ensure that the fan unit is positioned at least 3 m away from a chimney pipe. The unit must not be used in locations where it could be subjected to direct water spraying. Certain situations may require the use of acoustic insulation materials. Check that the unit is complete and undamaged when you take it out of the packaging. If in doubt about this, contact DUCO / your DUCO distribution point.

Electrical equipment should be handled with care.

- Never touch the unit with wet hands.
- Never touch the unit when barefoot.

Do not use the unit in the presence of flammable or volatile substances such as alcohol, insecticides, petrol etc. Make sure that the electrical system to which the unit is connected, complies with the stipulated conditions. Do not expose the device to weather conditions. Do not place any objects on the unit. Do not use the unit as an extractor for water heaters, heating systems, etc. Ensure that the unit discharges into a single exhaust duct that is suitable and installed for the purpose and exhausts to the outside. Ensure that the electrical circuit is not damaged. Always adhere to the safety instructions in the manual when installing the device. Failure to adhere to these safety instructions, warnings, notes and instructions could result in damage to the DucoBox Silent or in personal injury for which DUCO NV cannot be held liable. The DucoBox Silent requires to be installed in accordance with the general and locally applicable construction, safety and installation regulations of municipal and other authorities. Only an accredited installer is permitted to install, connect and commission the DucoBox Silent, as described in this manual. Keep the manual close to your unit. Maintenance instructions must be followed closely in order to avoid damage and/or wear. It is recommended that a maintenance contract be taken out to ensure the unit is regularly inspected and cleaned. The device must be fitted in a touch-safe manner. This means, among other things, that under normal operating conditions no-one can reach moving or electrically live parts of the fan without intending to do so for operations such as:

- Taking off the lid.
- Taking the motor module out of the fan after removing the lid.
- Disconnecting a duct or control valve from the connection opening during normal operation.

It ought to be impossible to touch the fan by hand. Ducting must therefore always be connected to the DucoBox Silent before it is put into operation. Therefore, at least 900 mm of ducting must be connected to the unit. The DucoBox Silent satisfies the legal requirements imposed on electrical equipment. Always ensure that before work begins, the device is isolated from the power supply by removing the power cord from the wall socket or by switching off the fuse. (Use a measuring instrument to check that this is actually the case!) Use suitable / appropriate tools to work on the unit. Use the unit only for applications for which it has been designed, as stated in this manual. The ventilation unit should operate permanently, i.e. the DucoBox Silent must never be switched off (legal obligation). The electronic components of the ventilation unit may be live. In the event of a fault, contact a professional installer and have repairs carried out only by qualified personnel. This unit is not intended for use by people (including children) with reduced physical, sensory or mental capabilities, or who lack experience of know-how, unless they are supervised or have been given instructions on the use of the unit by a person who is responsible for their safety. Children must be supervised to ensure that they do not play with the unit.

If the power cord is damaged, it must be replaced by the manufacturer, after-sales support or individuals with comparable qualifications in order to prevent any hazard.

The user is responsible for safely removing the ventilation unit at the end of its service life, in accordance with locally applicable laws or regulations. You can also take the unit to a collection point for used electrical equipment.

The unit is only suitable for housing construction and not for industrial use, such as swimming pools and saunas.

When handling electronics, always take ESD¹ inhibiting measures, such as wearing a grounded wristband.

Modifications to the unit or to specifications stated in this document are not permitted. Do not pull on the cord to remove the plug from the socket.

Always refer to the installer of your combustion appliance to establish whether there is a risk of flue gas ingress into the dwelling. Check that the voltage shown on the type plate matches the local mains voltage before connecting the unit. You will find the type plate inside the box.

¹ ESD = electrostatic discharge

03 Mounting

03.A Position

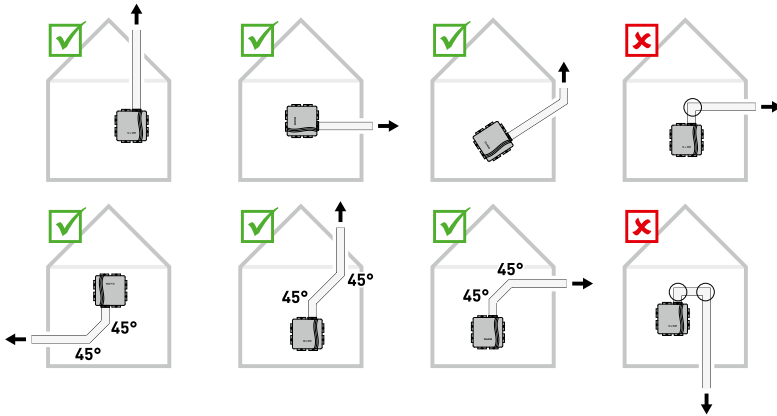

03.B Fixing

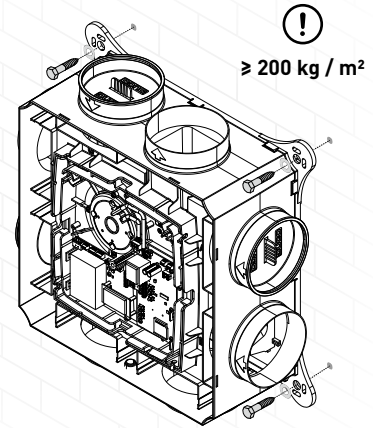

03.C Air duct connections

Keep down restriction. A non-return flap is required when discharging into a manifold.

Be sure to take note of the '10 unmissable tips' as well when fitting the DucuBox. Avoiding excessive use of bends, especially angles greater than 90° and adhering to the diameter guidelines for the ductwork will ensure that the ventilation box is able to do its job satisfactorily. Failure to take account of this recommendation may result in a highly energy and maintenance-intensive system that gives rise to frequent excessive noise levels.

10 UNMISSABLE TIPS

The smooth running of your DUCO ventilation system is totally dependent on the choice and the quality of implementation of the duct system!

Has the duct system been optimized? Ask professional advice from your duct supplier. It saves you time, ensures quality and provides energetic advantage for the end user!

DISCLAIMER: no rights can be derived from this document. All tips are only advisory. All those carrying out the work can, depending on the project at hand, determine for themselves which tips are feasible and/or useful.

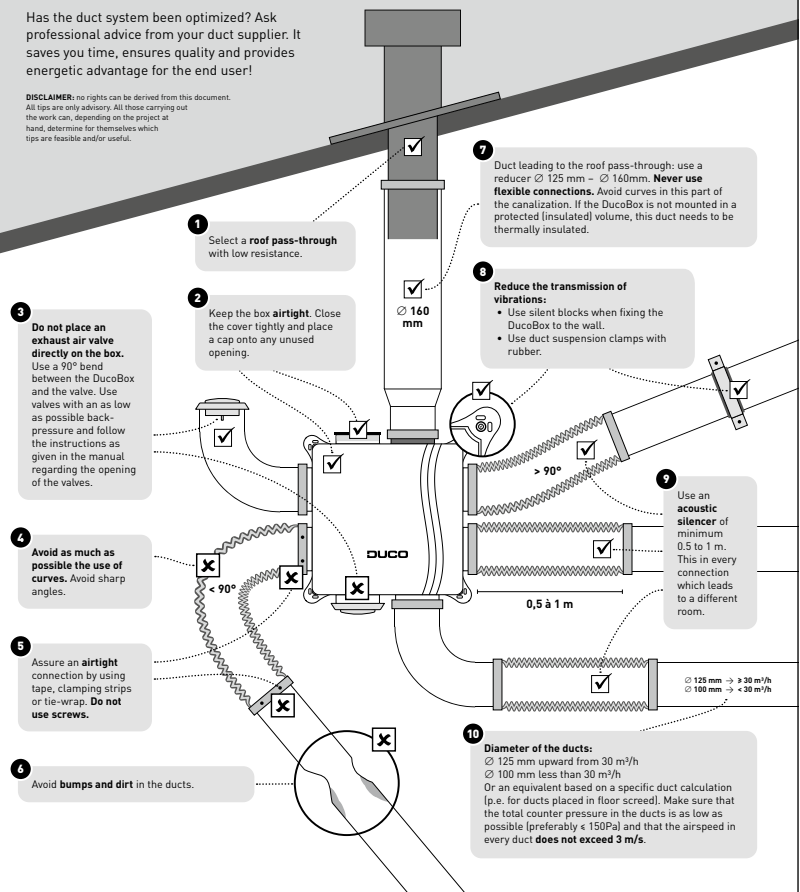

04 Wiring

04.A Connections & buttons

CONNECTORS	
1	Power 230 VAC
2	Perilex
3	Humidity Boxsensor
4	CO ₂ Boxsensor
5	Duco Network Tool
6	Fan

BUTTONS	
A	UP
B	ENTER
C	DOWN
D	HIGH
E	LOW
F	INST

Illustrations and connections may vary depending on product configuration. Incorrect connection or failure to follow the instructions may result in damage to the connected devices.

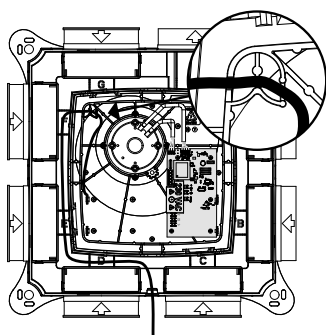

Strain relief

It is mandatory to place the power supply cable in the slot provided, as shown in the drawing, before powering up the DucoBox.

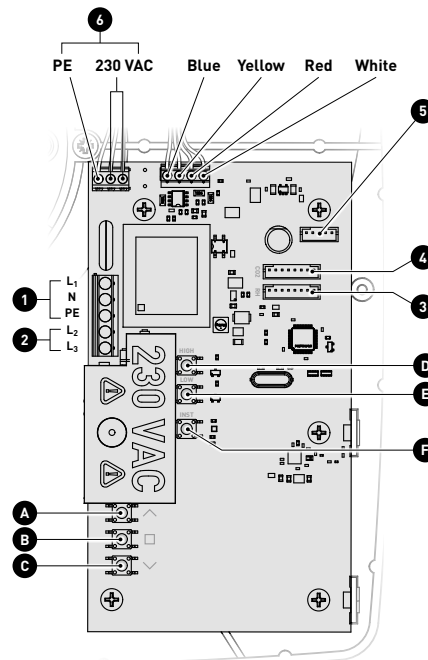

04.B Wiring diagram

The DucoBox Silent communicates with components through a wireless (RF) connection. RF components have a maximum free-field range of 350 metres. This distance will be much less in a building because of obstacles. Therefore you will need to allow for features such as walls, concrete and metal. All components (except those which are battery powered) also act as repeaters. Signals from components that are unable to make a (strong) connection with the controller are forwarded automatically via no more than one other non-battery-powered component (= hop). Please refer to information sheet [RF communication \(L8000018\)](#) at www.duco.eu for further information.

DUCO RF	
Power supply	230 VAC
Wiring	1,5 mm ²
Frequency	868 MHz
Maximum distance	350 m, free field (less through obstacles)
Maximum number of components	Up to 25 wireless components in a single system

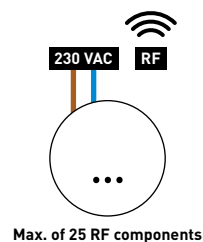
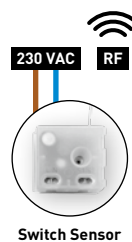
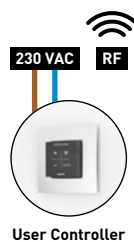
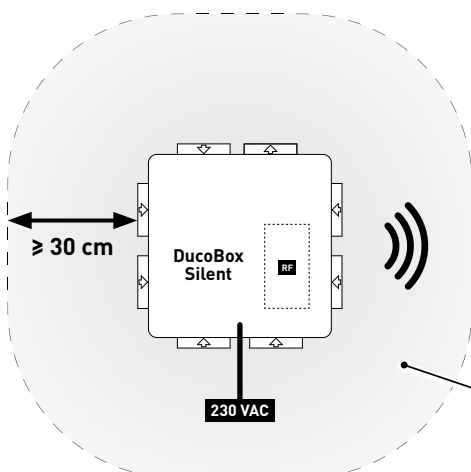

RF obstacle-free zone

Do not place any obstacles causing RF interference or other devices with an RF connection within a radius of **at least 30 cm** around the RF component. We take these to include items such as washing machines, tumble dryers, ironing boards, etc.

05 Additional control options

05.A 3-position switch* via Perilex

The last action on any user controller is always leading. The ventilation position on the 3-position switch can therefore be overruled by another user controller, such that an incorrect ventilation position will be visible on the 3-position switch.

Please refer to the manual with the Duco Perilex plug for more information.

* The 3-position switch is not a DUCO component.

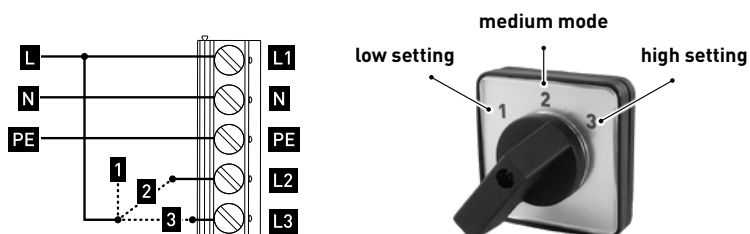

05.B Boxsensors

Boxsensors can be built into a DucoBox Silent and provide CO₂ and/or humidity measurement in an air duct. A DucoBox Silent can contain a **maximum of one CO₂ and one Humidity Boxsensor**. If the living room (CO₂ measurement) and bathroom (humidity measurement) are connected to the same duct/zone, the two Boxsensors can be clipped together.

Fitting + connecting Boxsensor

- 1 Twist the Boxsensor(s) into the desired duct in the box until the Boxsensor clicks home.
- 2 Connect the Boxsensors to one of the two connectors provided on the DucoBox Silent PCB.

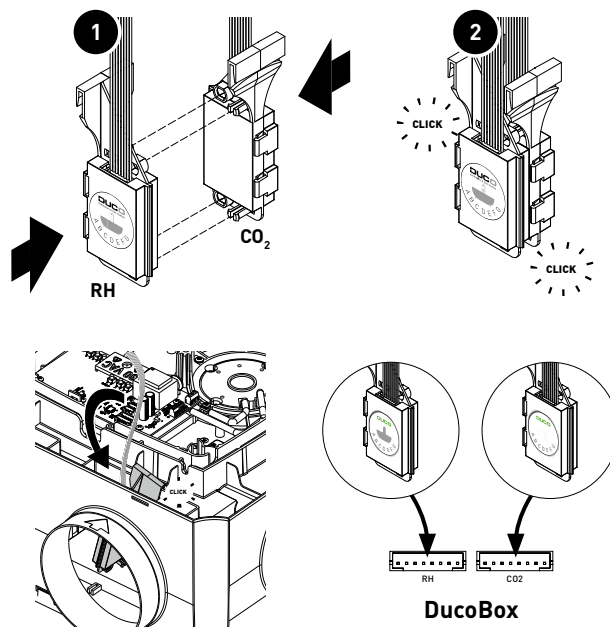

06 Electrical installation

06.A Changing settings

Most of the factory settings for the network and components will be satisfactory as they are, however, depending on the situation, it may be desirable to change some parameters, such as the CO₂ setpoint. This can be done using the **Duco Network Tool***. This user-friendly software also enables problems in the system to be pinpointed. The Duco Network Tool is issued to every installer after attending a free training course at the **Duco Academy***. Please refer to our website or your DUCO dealer for further information.







* Only in Belgium and the Netherlands

06.B Installer / User mode

To add components to the network, remove or replace, the system should be put in 'Installer mode'. The LED on each component indicates the component's active mode (see table in the next section).

'Installer mode' can be activated by pressing the DucoBox Silent Connect 'INST' button (see drawing in section "05.A Connections & buttons" on page 6). When the LED on the controller starts flashing green, 'Installer mode' is active. Press 'INST' again to return to 'User mode' (LED fully on or off). The system reverts automatically to 'User mode' after 15 minutes of inactivity.

06.C LED indications

	RED (blinking slowly) Not in network	RED (blinking rapidly) Busy pairing
	GREEN (blinking slowly) In network	GREEN (blinking rapidly) In network, waiting for associated components
	YELLOW (clignotement rapide) Transitional phase (please wait)	YELLOW (on) Initialising (system configuration in progress)
	WHITE or OFF Normal	
	BLUE Visualisation of component when changes are made via the controller.	
	ORANGE The system is not working correctly because the DucoBox has not been calibrated. Restart the DucoBox. Follow the guidelines in '10 essential tips' if the problem recurs continually.	

06.D Setting type of home

Setting the type of home and number of occupants correctly will provide the ventilation system with a better basis to adjust the mid-position. There are two types of home: low-rise (e.g. a house) and high-rise (e.g. a flat). **Configuration of this component is obligatory in the Netherlands.** The standard setting for a DucoBox is as a low-rise home for 4 (or more) occupants.

Setting type of home

- 1 Ensure that 'Installer Mode' has been activated (via the 'INST' button).
- 2 Press 'LOW' for a low-rise or 'HIGH' for a high-rise home.
- 3 The yellow LED (see illustration) will flash in a pattern that indicates the **number of occupants**: Once, twice (applies for 3 occupants as well) or 4 times (applies for 4 occupants or more). Press 'LOW' or 'HIGH' respectively again until the LED pattern matches the correct number of occupants.
- 4 Press the 'INST' button to exit 'Installer mode'.

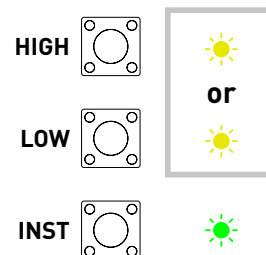

Pairing components



Never pair more than one system with RF components at the same time. If you do so, a component could be paired to the wrong network, (e.g. the neighbours' DucoBox).

Example of a pairing sequence

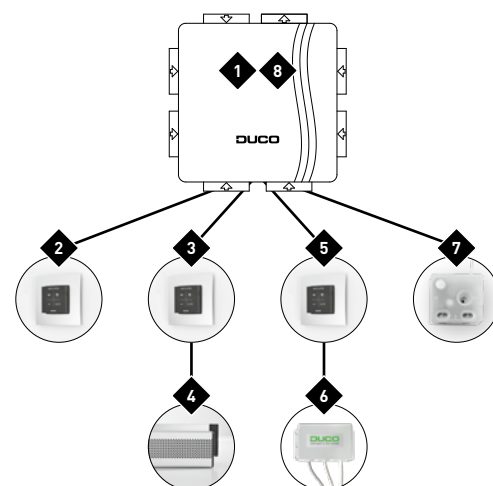

x indicates the order in which a button of the component must be pressed controls component

Pairing components on the DucoBox Silent

- 1 Activate 'Installer mode' by tapping 'INST' on the DucoBox. The LED will flash green rapidly.
- 2 Add control components by **tapping once on the component to be paired**. The LED will flash red briefly and then start to flash green rapidly. Repeat this step until all remaining components in the current zone have been paired.
- 3 For RF components: start with the closest component to the controller. If the first pairing is unsuccessful, another component may be tried first, which can then act as a hop for components that are unable to make a direct connection with the DucoBox.
- 3 Once all components have been paired, 'Installer mode' can be deactivated by tapping 'INST' on the DucoBox Silent. The LEDs on all components will stop flashing.

Please refer to the manual with the components for more detailed information.

06.E Removing / replacing components

Removing paired components from the network or replacing is **only possible within 30 minutes after the component is paired in or is restarted**. Restarting can be done by disconnecting the power for a moment. After a time-span of 30 minutes, remove and replace operations are ignored. This is valid for **all components from date of manufacture 170323**.

Removing a component

1

Activate 'Installer mode' by **long-pressing 2 diagonal buttons on a paired user controller**. The LED will flash green rapidly.

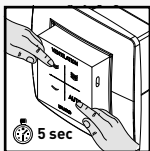

2

Press **once and hold** a button on the component to be removed in order to remove it from the network.

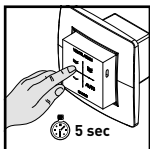

3

Deactivate 'Installer mode' by pressing the 4 buttons on a **paired user controller** simultaneously (or using the palm of your hand on a control featuring touch buttons). The LED will turn white.

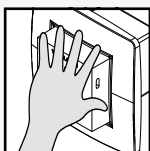

Replacing a component

1

Activate 'Installer mode' by **long-pressing 2 diagonal buttons on a paired user controller**. The LED will flash green rapidly.

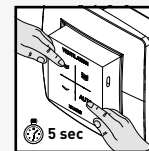

2

Press **2x briefly** on the button of the component to be replaced.

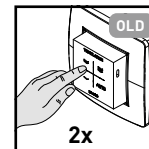

3

Press the button of the new component **once briefly**. The latter will take on all settings / connections in the network.

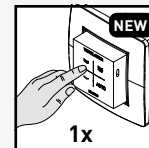

4

Deactivate 'Installer mode' by pressing the 4 buttons on a **paired user controller** simultaneously (or using the palm of your hand on a control featuring touch buttons). The LED will turn white.



06.F Tips

- **Removing all components from the network (e.g. in the event of problems):** Activate 'Installer mode' and long-press 'INST' until the LED starts flashing red. The DucoBox will reboot (around 15 seconds) and the LED will stop flashing.
- **Restore factory settings for the DucoBox and all paired components (AS FROM DucoBox version 18xxxx):** Long-press 'INST' and 'ENTER' if not in 'Installer mode'. The network remains in place.
- Use the **Duco Network Tool** to read out information from components.

07 Air calibration

For the system to operate correctly, the air volume must be adjusted. This will ensure its operation is as quiet as possible and energy-efficient. For information on determining ventilation flow rates, see the Instruction sheet Checking product references and flow rates on www.duco.eu.

07.A Air calibration procedure for DucoBox Silent





The air calibration procedure must be carried out on a calm day (no more than wind force 2: leaves rustling, feeling the wind in one's face).

Air calibrating the DucoBox Silent

Set all exhaust vents so they match the desired flow rate in accordance with the table below. Proper pre-setting makes for rapid and correct configuration.

1

Flow rate	DucoVent Design	DucoVent Basic and other vents
75m ³ /h		100 % open
50 m ³ /h		50 % open
25 m ³ /h		25 % open

When using DucoVent Design exhaust vents always leave the outer ring in place for acoustic effect.

Example

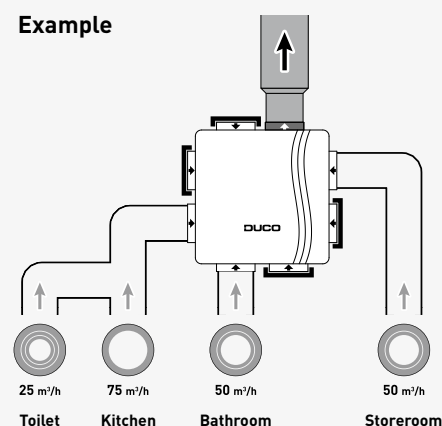

2

Before activating air calibration mode:

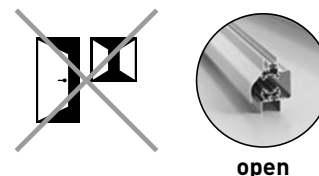

- Close **all** windows and doors.
- Ensure that **all duct openings in the DucoBox are fully closed and that the DucoBox cover is closed!**
- Avoid air leaks in the ventilation ducts.
- Set all window ventilators to the open position



Press **'HIGH'** or **'LOW'** to activate the configuration mode for 30 minutes. **Then close the cover firmly.**

Which configuration mode should I choose?

3

Button	Air calibration using 'HIGH'	Air calibration using 'LOW'
	Low mode (10 %)	Low mode (14-33 %)*
	Medium mode (50 %)	High mode (100 %)
	High mode (100 %)	Boost mode (143-333 %)*

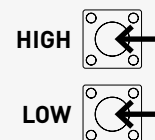

The percentages in the table indicate what percentage of the flow rate configured will be extracted. The configuration mode chosen does not affect the operation of the AUTO mode.

* In the 'LOW' configuration, the percentage in low mode and boost mode depends on the type of home (see section "07.D Setting type of home" on page 9) and limited to the maximum achievable ventilation system flow rate.

4

Close the DucoBox cover. Ensure it forms an **airtight** seal with the DucoBox.

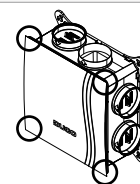

- 5 Select the duct with the highest flow rate and restriction.

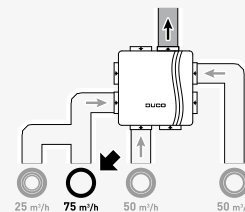

- 6 Measure at the vent and adjust the DucoBox rpm until the desired flow rate is obtained. This can be done in two ways:
- Using the (lower) and (higher) buttons on a paired User Controller or Room Sensor*.
 - Using the 'DOWN' and 'UP' buttons on the DucoBox. This requires the cover to be removed temporarily. **Always close the cover after every measurement.**

One button press equals 1% (= about 2 to 3 m³/h per button press depending on duct resistance).

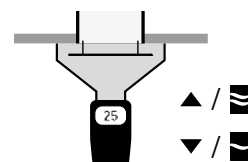

- 7 Now measure the other vents. **The flow rate from these other vents must only be adjusted at the vents themselves.**

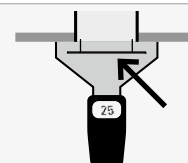

- 8 Repeat steps 6 and 7 until the desired flow rate has been obtained at each vent.

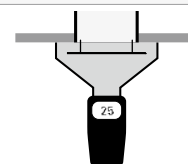

- 9 Exit configuration mode. This can be done in two ways:
- Long-press 'AUTO' on a paired User Controller or Room sensor* until the 4 LEDs light up white briefly and then turn yellow again.
 - Press 'ENTER' in the DucoBox and then immediately close the lid on the DucoBox. If the cover was not closed, you can pull the plug out of the power socket for a few seconds after closing the cover in order to reboot the DucoBox.

The DucoBox will now perform calibration by temporarily increasing the speed. This may take up to 1.5 min. Calibration is complete when the DucoBox slows down, the LEDs of the 'AUTO' button on the User Controllers / Room Sensors turn white, and the LED on the DucoBox turns white.

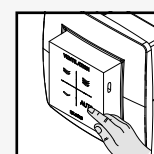



* Depending on the software version of the User Controller.

07.B Checking

The steps set out below can be used to check whether flow rates have been set correctly.

Checking configured flow rate

- 1** The configured flow rate is dependent on whether the 'HIGH' or 'LOW' configuration mode has been chosen. Press  for 'HIGH' calibration (= standard) or  for 'LOW' calibration on a random user controller to have the system run for 15 minutes at 100 % of the requested flow rate.

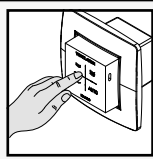
- 2** Measure the flow rate at the exhaust vents.

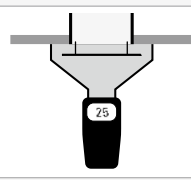
- 3** After the check, the system can be reset to the desired ventilation mode. If you do not do so, the system will automatically revert to the AUTO mode after 15 minutes.

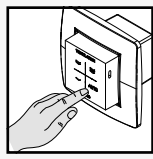

08 Maintenance & service

Please refer to the maintenance instructions at www.duco.eu and view the videos on duco.tv for more information.

For service problems as a user:

Please contact your installer. Keep the serial number of your product to hand.

In case of service problems as an installer:

Please contact your retailer of DUCO products. Keep the serial number of your product to hand.

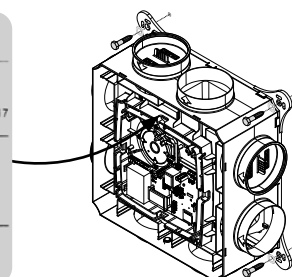

Sticker on the inside of the DucoBox

09 Warranty

All warranty conditions concerning the DucoBox and DUCO's ventilation systems can be found on the DUCO website. Complaints must be made in writing to DUCO by the installer or the DUCO distribution point, clearly stating the complaint and the order/invoice number with which the products were delivered. To do so, please fill out the complaint registration form, found on the DUCO website, mentioning the serial number and send it to service@duco.eu.

10 Legislation

Product fiche and energy labels can be consulted and downloaded at www.duco.eu.

Simplified EU declaration of conformity



Hereby DUCO Ventilation & Sun Control declares that the radio equipment type DucoBox Silent is in compliance with Directive 2014/53/EU.

The full text of the EU declaration of conformity is available at the following internet address:
en.duco.eu/ducobox-silent

Frequency band	868,3 MHz
Maximum radio frequency power	0,4 dBm

Installed by:

DUCO