

DucoBox Focus

ENGLISH **en**

Product version **17xxxx** and above

Installation guide



Video instructions
www.duco.tv

Table of contents

01	Introduction	3
02	Regulations and safety instructions	4
03	Mounting	5
03.A	Positioning	5
03.B	Fixing	5
03.C	Air duct connections	5
04	Wiring	6
04.A	Connections & buttons	6
04.B	Wiring diagram	6
05	Control valves	7
05.A	Mounting the control valves	7
05.B	Pairing the control valves	8
05.C	Removing / replacing control valves	8
05.D	LED indications	8
06	Additional control options	9
06.A	Duco Connectivity Board	9
07	Electronical installation	10
07.A	Installer / User mode	10
07.B	LED indications DucoBox Focus	10
07.C	Pairing components	10
07.D	Removing / replacing components	12
07.E	Tips	12
08	Flow rate calibration	13
08.A	Air calibration procedure for DucoBox Focus	13
08.B	Checking	14
09	Maintenance & service	15
10	Warranty	15
11	Legislation	15

Translation of the original instructions

See www.duco.eu for information regarding warranty, maintenance, technical data, etc.

Installation, connection, maintenance and repairs are to be carried out by an accredited installer. The electronic components of this product may be live. Avoid contact with water.



01 Introduction

Congratulations on your DucoBox Focus, the smartest box in Europe! The DucoBox Focus performs two functions in a DUCO Demand-Controlled Natural Ventilation System:

On the one hand it is the **extractor fan** that exhausts contaminated air with excessive CO₂ content or relative humidity. Thanks to integrated control valves, air is only exhausted in the zone that requires it.

On the other hand, it is the **controller**, or brain of the system. It receives and interprets signals from components (measurements from sensors or manual input), on the basis of which it controls the ventilation system.

It is inadvisable to connect the DucoBox (via a duct or directly) to an extractor hood, regardless of type. This usually causes excessive fouling in the DucoBox, which affects its operation or has a more direct effect on the flow rate.

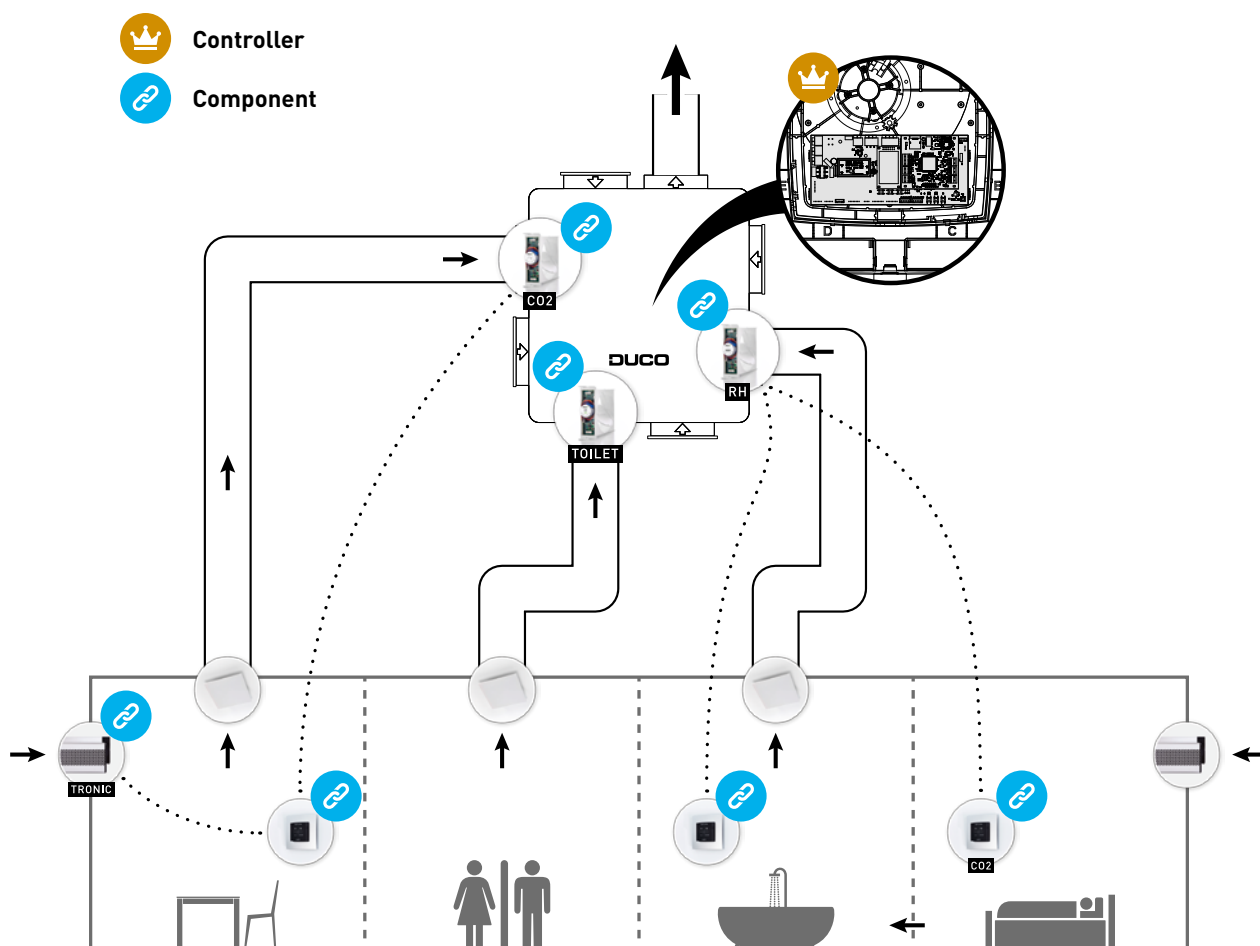

02 Regulations and safety instructions



The installer is responsible for installing and commissioning the unit.



Do not install this product in areas where the following are present or could occur:

- **Excessively greasy atmosphere.**
- **Corrosive or flammable gases, liquids or fumes.**
- **Room air temperature above 40 °C or below -5 °C.**
- **Relative humidity higher than 90 % or outdoors.**
- **Obstacles that prevent access to or the removal of the fan unit.**
- **Bends in the ducts immediately upstream of the fan unit.**
- **The DucoBox Focus must not be connected to a (motorless) extractor hood or tumble dryer.**

Take care to ensure that the electrical supply is a 230 V, single-phase earthed, 50/60 Hz, AC system. The device must be connected to an earthed and fused wall socket. Preferably mount the unit in an enclosed space. The fan unit can only be used with the appropriate DUCO accessories and user controller(s). The installer must ensure that the fan unit is positioned at least 3 m away from a chimney pipe. The unit must not be used in locations where it could be subjected to direct water spraying. Certain situations may require the use of acoustic insulation materials. Check that the unit is complete and undamaged when you take it out of the packaging. If in doubt about this, contact DUCO / your DUCO distribution point.

Electrical equipment should be handled with care.

- Never touch the unit with wet hands.
- Never touch the device when barefoot.

Do not use the unit in the presence of flammable or volatile substances such as alcohol, insecticides, petrol etc. Make sure that the electrical system to which the unit is connected, complies with the stipulated conditions. Do not expose the device to weather conditions. Do not place any objects on the unit. Do not use the unit as an extractor for water heaters, heating systems, etc. Ensure that the unit discharges into a single exhaust duct that is suitable and installed for the purpose and exhausts to the outside. Ensure that the electrical circuit is not damaged. Always adhere to the safety instructions in the manual when installing the device. Failure to adhere to these safety instructions, warnings, notes and instructions could result in damage to the DucoBox Focus or in personal injury for which DUCO NV cannot be held liable. The DucoBox Focus requires to be installed in accordance with the general and locally applicable construction, safety and installation regulations of municipal and other authorities. Only an accredited installer is permitted to install, connect and commission the DucoBox Focus, as described in this manual. Keep the manual close to your unit. Maintenance instructions must be followed closely in order to avoid damage and/or wear. It is recommended that a maintenance contract be taken out to ensure the unit is regularly inspected and cleaned. The device must be fitted in a touch-safe manner. This means, among other things, that under normal operating conditions no-one can reach moving or electrically live parts of the fan without intending to do so for operations such as:

- Taking off the cover.
- Taking the motor module out of the fan after removing the cover.
- Disconnecting a duct or control valve from the connection opening during normal operation.

It ought to be impossible to touch the fan by hand. Ducting must therefore always be connected to the DucoBox Focus before it is put into operation. Therefore, at least 900 mm of ducting must be connected to the unit.

The DucoBox Focus satisfies the legal requirements imposed on electrical equipment. Always ensure that before work begins, the device is isolated from the power supply by removing the power cord from the wall socket or by switching off the fuse. (Use a measuring instrument to check that this is actually the case!) Use suitable / appropriate tools to work on the unit. Use the unit only for applications for which it has been designed, as stated in this manual.

The ventilation unit should operate permanently, i.e. the DucoBox Focus must never be switched off (legal obligation). The electronic components of the ventilation unit may be live. In the event of a fault, contact a professional installer and have repairs carried out only by qualified personnel. This unit is not intended for use by people (including children) with reduced physical, sensory or mental capabilities, or who lack experience of know-how, unless they are supervised or have been given instructions on the use of the unit by a person who is responsible for their safety. Children must be supervised to ensure that they do not play with the unit.

If the power cord is damaged, it must be replaced by the manufacturer, after-sales support or individuals with comparable qualifications in order to prevent any hazard.

The user is responsible for safely removing the ventilation unit at the end of its service life, in accordance with locally applicable laws or regulations. You can also take the unit to a collection point for used electrical equipment.

The unit is only suitable for housing construction and not for industrial use, such as swimming pools and saunas.

When handling electronics, always take ESD¹ inhibiting measures, such as wearing a grounded wristband.

Modifications to the unit or to specifications stated in this document are not permitted.

Do not pull on the cord to remove the plug from the socket.

Always consult the installer of your combustion appliance to establish whether there is any risk of flue gases entering the home.

Check that the voltage shown on the type plate matches the local mains voltage before connecting the device. You will find the type plate inside the box.

1 ESD = electrostatic discharge

03 Mounting

03.A Positioning

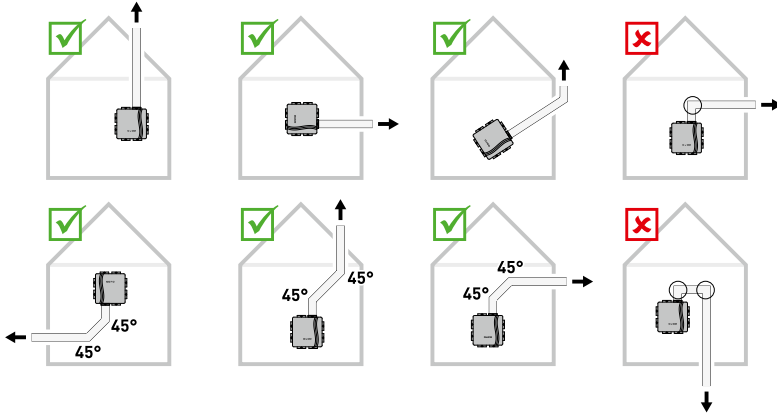

03.B Fixing

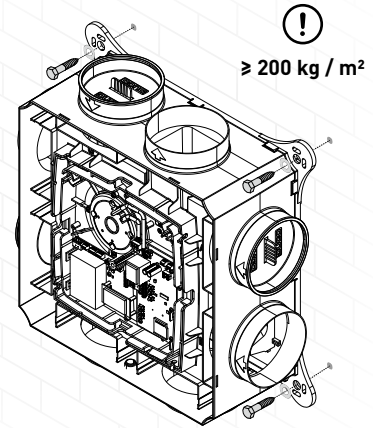

03.C Air duct connections

Limit the resistance. A non-return flap is required when discharging into a manifold. Position it at least 30 cm away from the Ducobox.

Be sure to take note of the '10 unmissable tips' as well when mounting the Ducobox. Avoiding excessive use of bends, especially angles sharper than 90° and adhering to the diameter guidelines for the ductwork will ensure that the ventilation box is able to do its job satisfactorily. Failure to take account of this recommendation may result in a highly energy and maintenance intensive system that gives rise to excessive noise nuisance frequently.

10 UNMISSABLE TIPS

The smooth running of your Ducu ventilation system is totally dependent on the choice and the quality of implementation of the duct system!

Has the duct system been optimized? Ask professional advice from your duct supplier. It saves you time, ensures quality and provides energetic advantage for the end user!

DISCLAIMER: no rights can be derived from this document. All tips are only advisory. All those carrying out the work can, depending on the project at hand, determine for themselves which tips are feasible and/or useful.

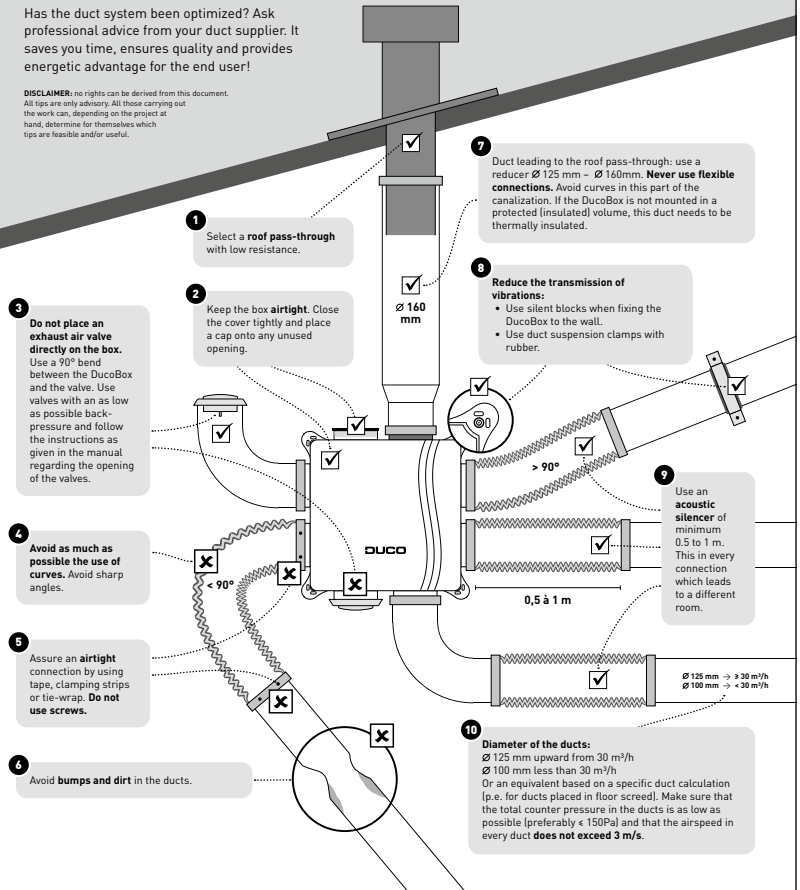

04 Wiring

04.A Connections & buttons

Strain relief

It is mandatory to place the power supply cable in the slot provided, as shown in the drawing, before powering up the DucoBox.

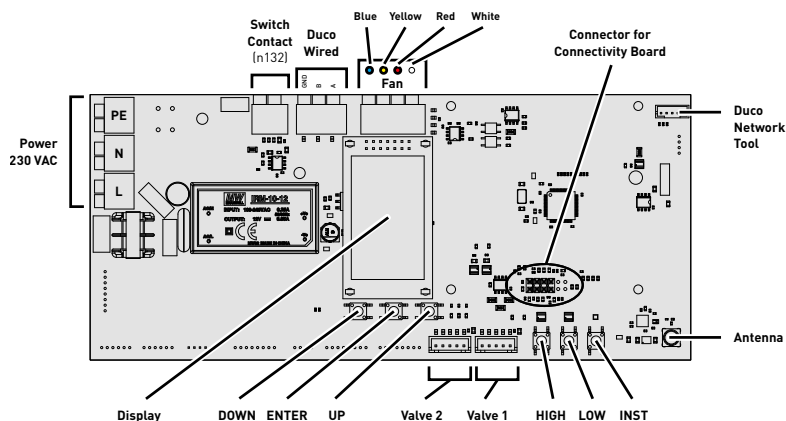
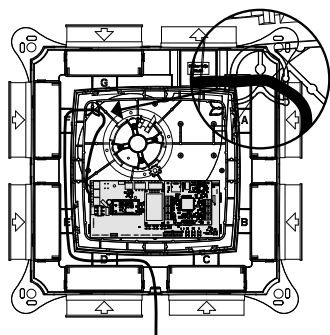

Illustrations and connections may vary depending on the version of the product. Incorrect connection or failure to follow the instructions may result in damage to the connected devices.

04.B Wiring diagram

The DucoBox Focus is able to communicate with DUCO components via a wireless (RF) or wired link. Both types of communication can be combined in one system. Communication with non-DUCO components is possible via the switch sensor.

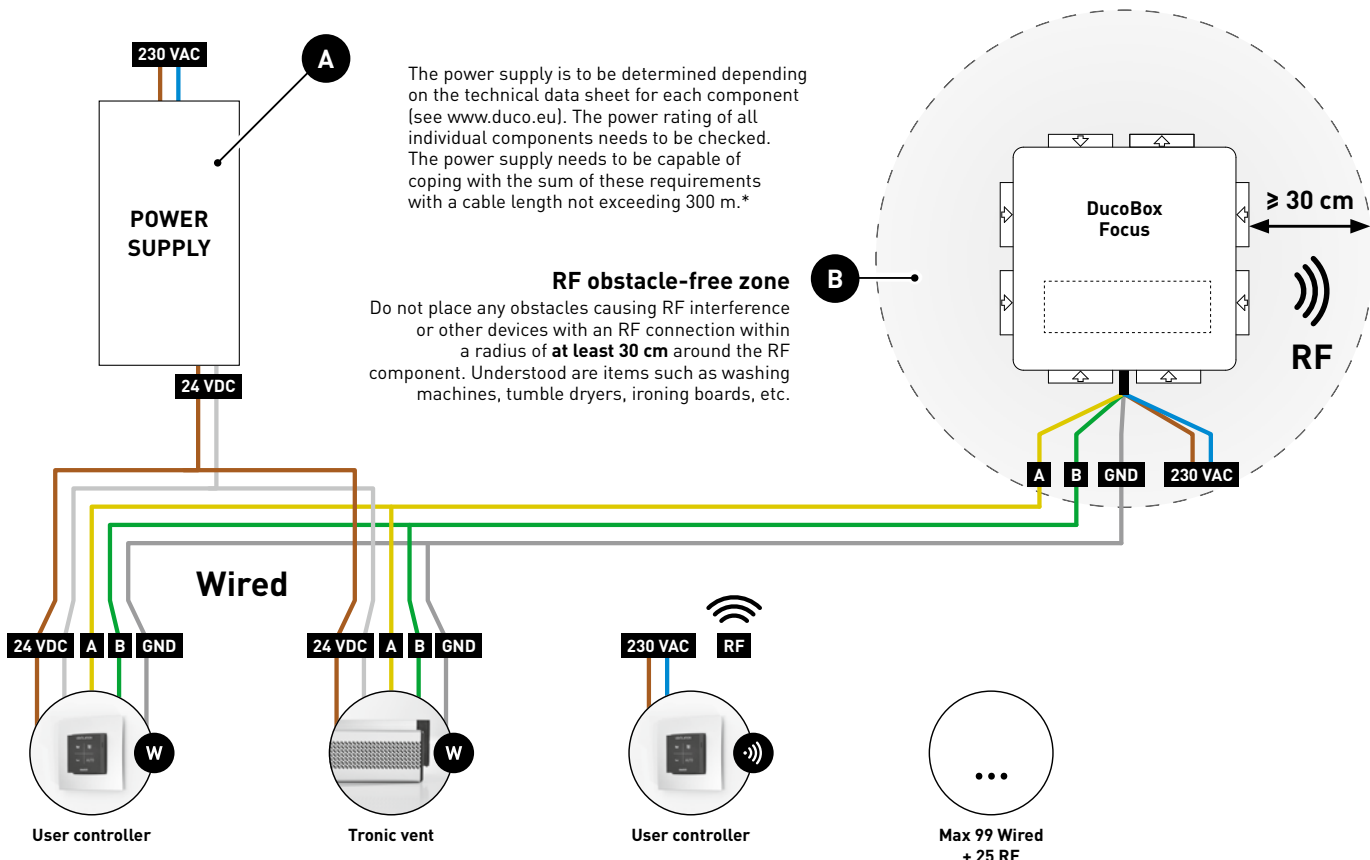

* Use a screened solid-core cable not exceeding 300 m in length, with 5 cores 0.75 mm each.

RF (wireless communication)

RF components have a maximum free-field range of 350 metres. This distance will be much less in a building because of obstacles. Therefore, you will need to take objects such as walls, concrete and metal into account. All components (except those which are battery powered) also act as repeaters. Signals from components that are unable to make a (strong) connection with the controller are forwarded automatically via no more than one other non-battery-powered component (= hop). Please refer to the information sheet **RF communication (L8000018)** at www.duco.eu for further information.

DUCO RF	
Power supply	230 VAC
Wiring	1,5 mm ²
Frequency	868 Mhz
Maximum distance	350 m, free field (less through obstacles)
Maximum number of components	Up to 25 wireless components in a single system

Wired (cabled communication)

Wired components can be daisy-chained (= recommended). This means that a separate cable will not be required for each component. A single central power supply can be used.

The cable required is a 5 x 0.75 mm² data cable. We strongly advise using a shielded cable. This is to prevent any interference that may affect the data communication. Any Tronic window ventilators will be supplied with a 5 x 0.25 mm² cable which can be connected via a splicing terminal block.

DUCO WIRED	
Power supply	24 VDC
Wiring	5 x 0,75 mm ² (5 x 0,25 mm ² from Tronic window ventilators)
Maximum distance	up to 300 m
Maximum number of components	Up to 99 wired components in a single system

05 Control valves

The control valves, whether or not they are fitted with a sensor for measuring CO or humidity, can be built into the DucoBox Focus. Together with the fan, they ensure the correct exhaust airflow rate in the right room.



A control valve with combined CO₂ and RH measurement can only be used with a DucoBox Focus with a software version of 11.2 or higher.

A DucoBox Focus can contain up to a maximum of 7 control valves (= one per supply duct). This can be expanded to a maximum of 11 control valves by using the 'Control Valve Manifold' (item 0000-4454).



A control valve must always be provided for each ventilation duct connected!

05.A Mounting the control valves

Slide the control valve into the locations provided in the DucoBox Focus. Connect the 'VALVE' connector on the DucoBox to **IN** on the control valve. If applicable, connect **OUT** on the valve to **IN** on another control valve to be added. At least one valve must be connected to the DucoBox at any time.

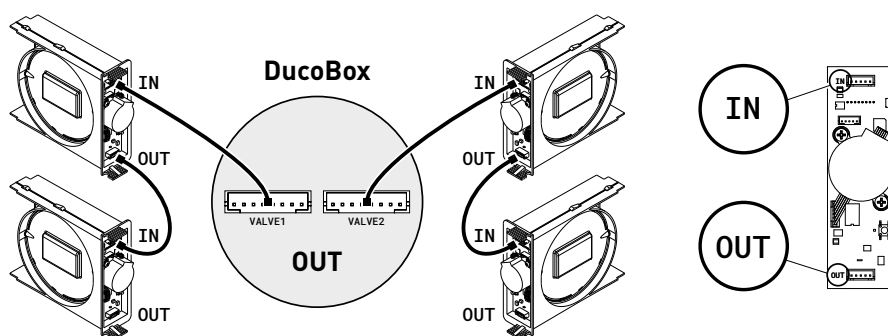

TIP: Use the letter labels on the DucoBox and the valves (A/B/C/D/E/F/G) to give these the same letter, so that the valves always remain in the same position.

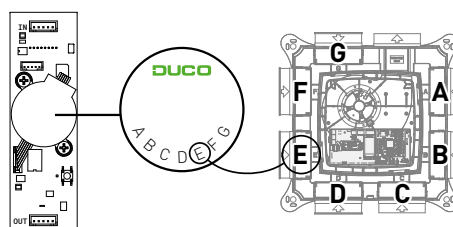

05.B Pairing the control valves

The control valves are paired automatically to the DucoBox whenever 'installer mode' is activated (see "Pairing components" chapter).

05.C Removing / replacing control valves

Taking control valve out temporarily

Follow these steps to take a control valve out of the unit **temporarily**, e.g. to clean it during maintenance. Make sure that the control valve is inserted back in the same location. Use the letter labels on the DucoBox and the relevant valve for this. The DucoBox will retain all its settings when the control valve is reconnected.

Temporarily removing control valve

- 1 Briefly press the button on the valve to close it for 15 minutes. The LED will go out.
- 2 Disconnect the wiring.
- 3 Slide the valve out of the DucoBox.

Permanently removing or replacing control valve

To remove a control valve permanently from the system or to replace it (e.g. in the event of a fault) it is important that it should be deregistered correctly. The DucoBox will not be able to be calibrated correctly if this is not done.

Permanently removing control valve

- 1 Briefly press the button on the valve to drive it shut.
- 2 Activate 'Installer mode' by pressing 'INST' on the DucoBox. The LEDs on the DucoBox and control valves will flash green rapidly.
- 3 Long-press the button **once** on the control valve to be removed in order to remove it from the network. **ATTENTION: any underlying components will also be removed from the network.**
- 4 Disconnect the wiring from the control valve to be removed and slide it out of the DucoBox.
- 5 Deactivate 'Installer mode' by pressing 'INST' on the DucoBox. All LEDs will stop flashing.

Replacing a control valve

- 1 Briefly press the button on the valve to drive it shut.
- 2 Activate 'Installer mode' by pressing 'INST' on the DucoBox. The LEDs on the DucoBox and control valves will flash green rapidly.
- 3 Short-press the button **twice** on the control valve to be replaced in order to remove it from the network.
- 4 Disconnect the wiring from the control valve to be replaced and slide it out of the DucoBox.
- 5 Slide the new control valve into the DucoBox and connect it.
- 6 Short-press the button on the new control valve **once**. The latter will take on all settings / connections in the network.
- 7 Deactivate 'Installer mode' by pressing 'INST' on the DucoBox. All LEDs will stop flashing.

05.D LED indications

In normal operation, the LED on the control valves will be white or off, depending on the control valve position. The brightness of the LED indicates the flow rate through the valve.

Please refer to "07.B LED indications on page 10 for the meaning of the remaining LED colours.

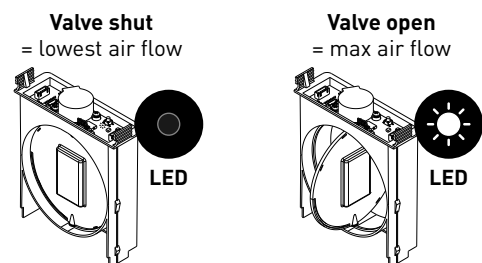

06 Additional control options

06.A Duco Connectivity Board

The optional circuit board allows linking towards home automation and building management systems via REST API (locally or via the cloud) or Modbus TCP (locally). Both are possible via Ethernet or Wi-Fi.

The Duco Connectivity Board also enables the Duco Installation App to be used. This application supports - and relieves - installers to control and maintain a ventilation system in a user-friendly way.

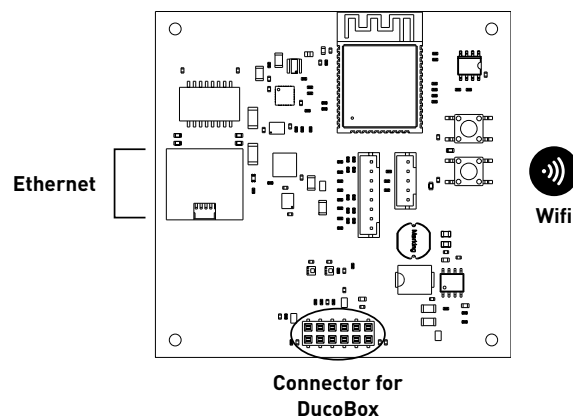







07 Electrical installation

07.A Installer / User mode

To add, remove or replace components to the network, the system should be put in 'Installer mode'. The LED on each component indicates the active mode of the component (see table in next section).

'Installer mode' can be activated by pressing the DucoBox Focus 'INST' button (see drawing in section "04.A Connections & buttons" on page 6. When the LED on the Controller unit starts flashing green, 'Installer mode' is active. Press 'INST' again to return to 'User mode' (LED fully on or off). The system reverts automatically to 'User mode' after 15 minutes of inactivity.

07.B LED indications DucoBox Focus

	RED (blinking slowly) Not in network	RED (blinking rapidly) Currently pairing
	GREEN (blinking slowly) In network	GREEN (blinking rapidly) In network, waiting for associated components
	YELLOW (blinking slowly) Transitional phase (please wait)	YELLOW (on) Initialising (system configuration in progress)
	WHITE or OFF Normal	
	BLUE Component is displayed (e.g. if changes are implemented via the Controller).	
	ORANGE The system is not working correctly because the DucoBox has not been calibrated. Restart the DucoBox. Follow the guidelines in '10 essential tips' if the problem recurs continually.	

07.C Pairing components

The DucoBox Focus is an extractor fan for a **zonal ventilation system**. This means that ventilation will only operate in the zones where it is needed (e.g. only in the bathroom while showering) for the most energy-efficient operation. Thus, in the example below, pressing the button in zone 1 will change the ventilation setting only for this zone. Pressing the Main controller will command all zones that are set to 'AUTO' at that point in time.

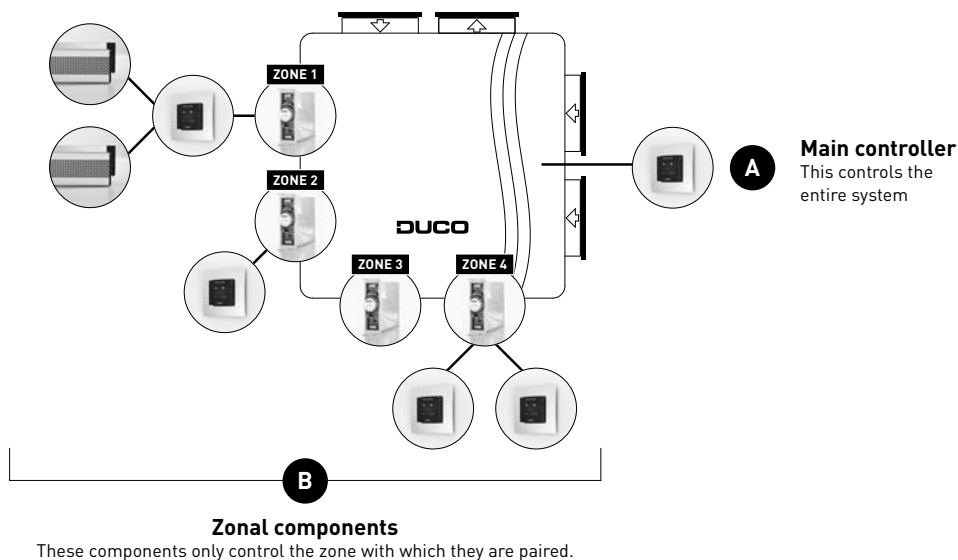

It is important that components are paired with the correct zone for this zonal operation. Components can be paired with the DucoBox Focus itself (controlling **all zones**) or with a control valve (controlling **a single zone**). A component will be paired in every case with the component (control valve or DucoBox) that is flashing rapidly. It is possible to pair several user controllers in one zone, but not to link one user controller to multiple control valves or DucoBoxes.



Never pair more than one system with RF components at the same time. If you do so, a component could be paired in the wrong network, (e.g. in the neighbours' DucoBox) or the component may not pair.



With RF components it is recommended to start with the component closest to the DucoBox. This enables this component to be used as a hop for components that are too distant from the DucoBox and unable to make a direct RF connection with the DucoBox.

Pairing components

- 1 Activate 'Installer mode' by tapping **'INST'** on the DucoBox. The LED will flash green rapidly.
- 2 **Pairing components on the DucoBox:**
Use this method for any components that are required to control the **entire system** (e.g. a main controller).
 - 2a Tap **on the button of the component to be paired once** while the LED on the DucoBox is flashing rapidly. The LED on this component will flash red briefly and then start to flash green rapidly.
- 3 **Pairing components with a control valve:**
Use this method for components that only control the **zone** connected to the control valve duct. Repeat these steps for each zone.
 - 3a **Tap the control valve once** so the LED starts to flash green rapidly. Underlying components can now be added in this zone.
 - 3b Add **control components** by tapping once on the component to be paired. The LED will flash red briefly and then start to flash green rapidly.
 - 3c Add any **window ventilators** by tapping once on the component to be paired. The LED will flash green slowly.
- 4 Once all components have been paired, 'Installer mode' can be deactivated by tapping **'INST'** on the DucoBox Focus. The LEDs on all components will stop flashing.

Please refer to the manual with the components for more detailed information.

07.D Removing / replacing components

Removing paired components from the network or replacing is **only possible within 30 minutes after the component is paired in or is restarted**. Restarting can be done by disconnecting the power for a moment. After a time-span of 30 minutes, remove and replace operations are ignored. This is valid for **all components from date of manufacture 170323**.

Removing a component

- 1 Activate 'Installer mode' by **long-pressing 2 diagonal buttons on a paired control**. The LED will flash green or yellow rapidly.

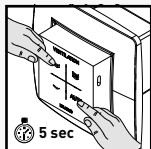

- 2 Press **once and hold** a button on the component to be removed in order to remove it from the network. **ATTENTION: any underlying components will also be removed from the network.**

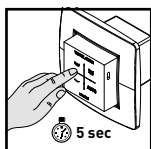

- 3 Deactivate 'Installer mode' by pressing the 4 buttons on a **paired control** simultaneously (or using the palm of your hand on a control featuring touch buttons). The LED will turn white.

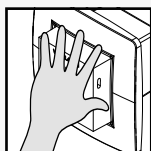

Replacing a component

- 1 Activate 'Installer mode' by **long-pressing 2 diagonal buttons on a paired control**. The LED will flash green or yellow rapidly.

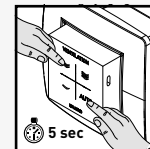

- 2 Briefly press **twice** on the button of the component to be replaced.

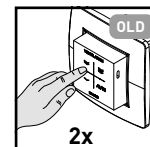

- 3 **Tap once** on the button of the new component. The latter will take on all settings / connections in the network.

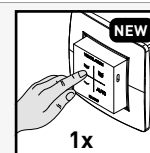

- 3 Deactivate 'Installer mode' by pressing the 4 buttons on a **paired control** simultaneously (or using the palm of your hand on a control featuring touch buttons). The LED will turn white.

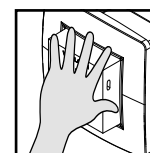

07.E Tips

- **Removing all components from the network (e.g. in the event of problems):** Activate 'Installer mode' and long-press 'INST' until the LED starts flashing red. The DucoBox will reboot and the LED will stop flashing.
- **Restoring factory settings for the DucoBox and all paired components (AS FROM DucoBox version 18xxxx):** Long-press 'INST' and 'ENTER' if not in 'Installer mode'. The network remains in place.
- Use the **DUCO Installation App** or the **DUCO Network Tool** to read out information from components.

08 Flow rate calibration

For the system to work correctly, it needs to be configured. This will ensure its operation is as quiet as possible and energy-efficient. For information on determining the ventilation flow rates, see Instruction Sheet Checking Product References and Flow Rates at www.duco.eu.

08.A Air calibration procedure for DucoBox Focus



The air calibration procedure must be carried out on a calm day (no more than wind force 2: leaves rustling, feeling the wind in one's face).

DucoBox Focus air calibration

1

The exhaust vents must be set depending on the situation. Proper pre-setting makes for rapid and correct configuration.

SITUATION 1: one vent per valve

Set **all vents to the fully open position**, regardless of the desired flow rate.

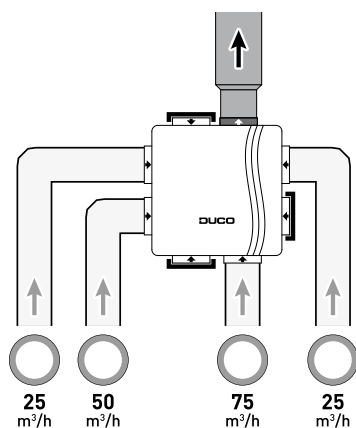

SITUATION 2: Multiple vents per valve with equal flow rates

Set **all vents to the fully open position**, regardless of the desired flow rate. Set the valve to the sum of the vent flow rates via the display menu or the Duco Network Tool. Example: 2 vents, 50 m³/h each → set valve to 100 m³/h.

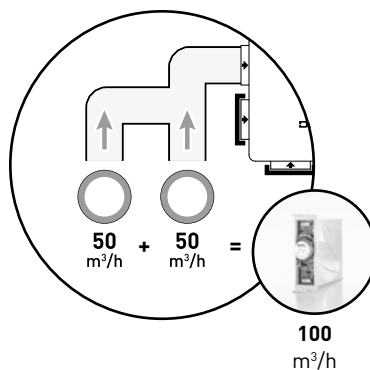

SITUATION 3: Multiple vents per valve with different flow rates

Set the exhaust vents so they match the desired flow rate **in line with the table below**. Set the valve to the sum of the vent flow rates via the display menu or the Duco Network Tool. Example: 25 m³/h vent and 75 m³/h vent → set valve to 100 m³/h.

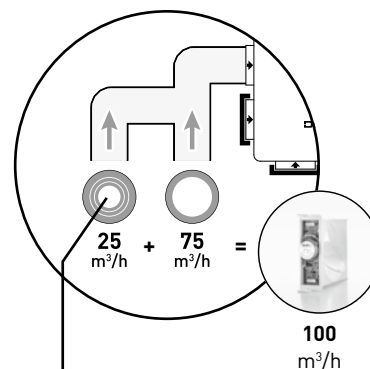

When using DucoVent Design exhaust vents always leave the outer ring in place for acoustic effect.

Flow rate	DucoVent Design	DucoVent Basic and other vents
75 m ³ /h		100 % open
50 m ³ /h		50 % open
25 m ³ /h		25 % open

Before activating air calibration mode:

- Close **all** windows and doors.
- Ensure that **all duct openings in the DucoBox are fully closed and that the DucoBox cover is closed!**
- Avoid air leaks in the ventilation ducts.
- Set all window ventilators to the open position. Any Tronic ventilators will open automatically.

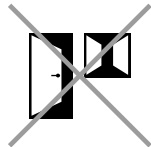
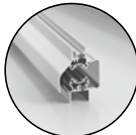
open

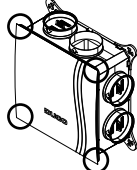

3 Pull the plug out of the socket and wait a few seconds.

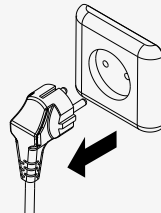

4 Put the plug back into the socket. The DucoBox will be configured automatically on start-up. Calibration takes 30 seconds + 1 minute per connected control valve.

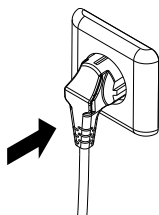

08.B Checking

The steps set out below can be used to check whether flow rates have been set correctly.

Checking configured flow rate	
1	Open the lid of the DucoBox.
2	Press 'HIGH' briefly. The DucoBox will remain in configuration mode for 30 minutes (as standard).
3	Close the lid.
4	Wait at least one minute to allow the ventilation system to stabilise.
5	Measure the vents. If a flow rate differs from the desired output, this can be adjusted via the display menu or using the Duco Network Tool.
6	If you finish before the standard setting of 30 minutes, re-open the DucoBox lid and press 'HIGH' again. Then close the lid.

09 Maintenance & service

Please refer to the maintenance instructions at www.duco.eu and view the videos on duco.tv for more information.

For service problems as a user:

Please contact your installer. Keep the serial number of your product to hand.

For service problems as an installer:

Please contact your retailer of DUCO products. Keep the serial number of your product to hand.

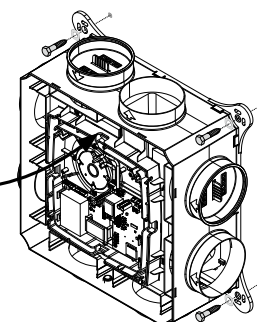

Sticker on the inside of the DucoBox

10 Warranty

All warranty conditions concerning the DucoBox and DUCO's ventilation systems can be found on the DUCO website.

Complaints must be made in writing to DUCO by the installer or the DUCO distribution point, clearly stating the complaint and the order/invoice number with which the products were delivered. In order to register the complaint, please use the complaint registration form found on the DUCO website and the product's serial number in your message to service@duco.eu.

11 Legislation

Product card, EC declaration of conformity and energy labels can be viewed and downloaded at www.duco.eu.

Installed by:

DUCO