

# LOUVRE WALL SYSTEMS



STAY UP-TO-DATE!

Download the latest  
version



[link.duco.eu/brochure](https://link.duco.eu/brochure)

**DUCO**

# HOME OF OXYGEN

DUCO Ventilation & Sun Control provides every building with a healthy supply of oxygen. With a comprehensive range of innovative natural and mechanical ventilation systems, either combined with external solar shading or otherwise, DUCO offers the ultimate guarantee of a healthy and comfortable indoor climate. The occupant's health is,

therefore, central to DUCO. A well-thought-out combination of basic ventilation, mechanical extraction, purge ventilation and solar shading ensures optimum air quality. DUCO provides an innovative solution for residential buildings, offices, schools or care centres where everyone feels at home.

**DUCO, Home of Oxygen**

**DUCO**

<b>GENERAL</b> .....	<b>4</b>
<b>PRODUCTS</b> .....	<b>6</b>
<b>DUCOWALL SOLID</b>	
DucoWall <b>Solid W 30Z</b> .....	8
<b>DUCOWALL SCREENING</b>	
DucoWall <b>Screening 35</b> .....	12
DucoWall <b>Screening 70</b> .....	13
<b>DUCOWALL CLASSIC</b>	
DucoWall <b>Classic W 20Z</b> .....	14
DucoWall <b>Classic W 20V</b> .....	15
DucoWall <b>Classic W 35V</b> .....	16
DucoWall <b>Classic W 50Z/30°</b> .....	17
DucoWall <b>Classic W 50Z</b> .....	18
DucoWall <b>Classic W 50/75Z</b> .....	19
DucoWall <b>Classic W 70V</b> .....	20
DucoWall <b>Classic W 45HP</b> .....	21
DucoWall <b>Classic W 50HP</b> .....	22
DucoWall <b>Classic W 130HP</b> .....	23
DucoWall <b>Classic W 80HP</b> .....	24
DucoWall <b>Classic W 60C</b> .....	25
<b>DUCOWALL ACOUSTIC</b>	
DucoWall <b>Acoustic W 75Z &amp; W 75L</b> .....	28
DucoWall <b>Acoustic W 150 &amp; W 300</b> .....	29
<b>DUCODOOR LOUVRE DOORS</b> .....	
DucoDoor Wall.....	31
DucoDoor Louvre.....	32
DucoDoor Grille.....	33
<b>ROOF TURRETS</b>	
Duco <b>Roof Turret Solid 30Z</b> .....	36
<b>IMPACT AND FALL-THROUGH PROTECTION</b> .....	<b>38</b>
<b>REFERENCE PROJECTS</b> .....	<b>40</b>
<b>VARIOUS</b> .....	<b>42</b>
Service.....	42
Overview of mullions.....	43
Technical specification table.....	44

**DISCLAIMER**

Illustrations in this catalogue may differ from actual product. Printing errors and/or changes excepted. DUCO reserves the right to amend this information at any time. The information stated is valid as at 04.07.2024 and may be subject to changes in legislation.

# A SOLUTION FOR EVERY SITUATION



## → Finish

Each type of louvre wall is available in any colour: **SAA, any RAL colour, textured paint, special paints/lacquers, etc.** Every type of louvre wall is lacquered as standard in SeaSide grade. In addition, every type of louvre wall in this brochure complies with the **Qualicoat** or **Qualanod** quality specifications.



## → Quick assembly

With DUCO's patented '**Turn-Click**' system for DucoWall Classic and Acoustic, plastic louvre holders are pre-fastened to the mullion. The louvre blades are easily clicked on to this.

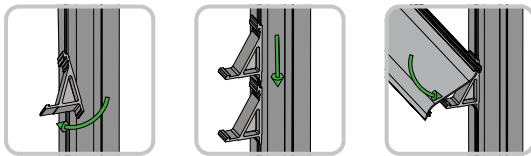

1. Turn

2. Click

3. Click

With DUCO's patented '**Direct Clip**' system for DucoWall Solid and Screening, the louvre blades are clicked onto the mullion directly, ensuring super-quick assembly.

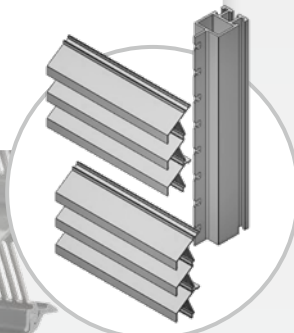

Triple  
Solid 30Z louvre blades

## → Vandalism and intrusion security



Solid louvre blades are very sturdy and '**vandal-proof**'.



RC2

Each type of louvre wall (DucoWall Solid, Classic\*, Acoustic and Screening) and the DucoDoor Louvre and Grille louvre doors have the option of being manufactured **burglary-resistant up to resistance class 2** in accordance with European standards.

\* Except for DucoWall Classic W 60C/2, W 60C/3 and DucoWall Acoustic W 300

## → Insect screen and vermin screen



With DucoWall Solid louvre blades with small punching slots (P1), the **perforated louvre blades** act as an insect screen. With all other types (Solid P2, Classic, Acoustic and Screening), **optional 2.3 x 2.3 mm or 6 x 6 mm stainless-steel mesh** can be selected.



P1



P2



Stainless-steel mesh



## → Ventilation capacity

Each louvre wall is tested extensively and optimised by DUCO's R&D department. The 'High Performance' HP louvre blades in the DucoWall Classic range ensure excellent airflow thanks to low resistance.

Airflow performance class	Ce or Cd
1	> 0,4
2	0,3 - 0,399
3	0,2 - 0,299
4	≤ 0,199



DucoWall Classic W 130HP

## → Water resistance

All DucoWall louvre wall systems have been tested by **BSRIA** in accordance with the water tightness tests developed in collaboration with HEVAC. The test simulates 75 litres per hour rainfall at a wind speed of 13 metres per second. A class is assigned to the louvre wall on the basis of the air velocity in the louvre wall and the % of watertightness.

EN13030

Class A	100 - 99 %
Class B	98,5 - 95 %
Class C	94,9 - 80 %
Class D	< 80 %

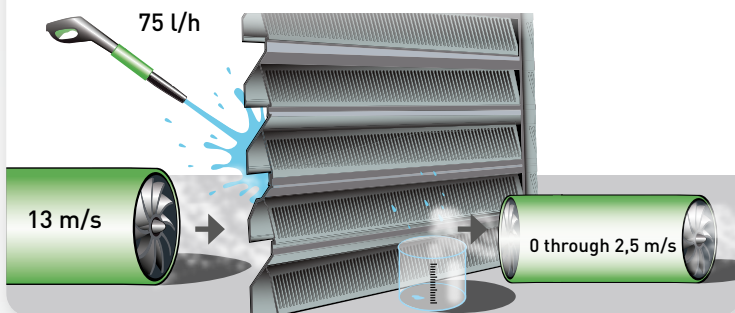

## → Penetration security

DucoWall Classic louvre walls with **V-louvre blades** are penetration proof.

## → Sound absorption

DucoWall **Acoustic** louvre blades are fitted on the inside with non-combustible mineral wool and are ideally suited for applications with high levels of noise intrusion.

## → STND and +OPT version

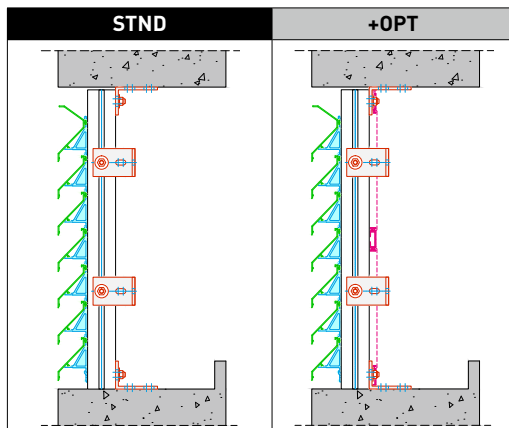

The technical values of our grilles have been tested in two ways:

### STND = 'Standard'

This is the standard version.

### +OPT = '+Options'

This is an optional version where the louvre wall has been tested incl. insect screen.

The **+OPT** version will often bring better results in terms of water resistance. See each product page for all values per grille type.

# PRODUCTOVERVIEW

## Ventilation capacity

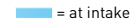
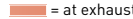
 = at intake  
 = at exhaust  
 The longer the bar, the greater the airflow.  
 STND and +OPT version: see page 5

## Maximum span

between two mullions at 800 Pa and pressure coefficient: 1.2

## DUCOWALL SOLID

Sturdy aluminium blades that connect to one another ensure **vandal-proof** louvre walls with a minimal support structure. **Very quick assembly** thanks to DUCO's patented 'Direct-Clip' system.

 <b>DucoWall Solid W 30Z</b>			see p. 8
---	---	---	----------

## DUCOWALL SCREENING













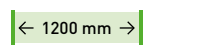

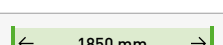

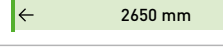

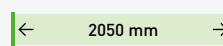

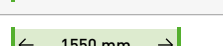

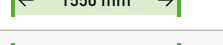

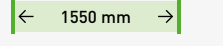
Aluminium louvre wall system that is eminently suitable for projects where the wall acts primarily as **screening**. These systems guarantee **very quick assembly**.

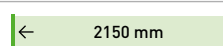
<b>DucoWall Screening 35</b>			see p. 12
------------------------------	---	---	-----------

<b>DucoWall Screening 70</b>			see p. 13
------------------------------	--	--	-----------

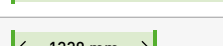

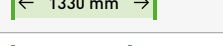
## DUCOWALL CLASSIC

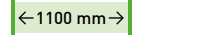
Aluminium louvre wall system with **louvre blade holders**. Quick assembly with DUCO's 'Turn-Click' system. These louvre blade holders can be fitted on the mullion separately, enabling a **perfect finish** to be achieved.

 <b>DucoWall Classic W 20Z</b>			see p. 14
 <b>DucoWall Classic W 20V</b>			see p. 15
 <b>DucoWall Classic W 35V</b>			see p. 16
<b>DucoWall Classic W 50Z/30°</b>			see p. 17
 <b>DucoWall Classic W 50Z</b>			see p. 18
 <b>DucoWall Classic W 50/75Z</b>			see p. 19
 <b>DucoWall Classic W 70V</b>			see p. 20
 <b>DucoWall Classic W 45HP</b>			see p. 21
 <b>DucoWall Classic W 50HP</b>			see p. 22
  <b>DucoWall Classic W 130HP</b>			see p. 23
 <b>DucoWall Classic W 80HP</b>			see p. 24
 <b>DucoWall Classic W 60C</b>			see p. 25

\* Impact and fall protection only applies in combination with Metal Clips.

### Ventilation capacity















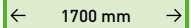

 = at intake  
 = at exhaust  
 The longer the bar, the greater the airflow.  
 STND and +OPT version: see page 5

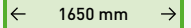
### Maximum span

between two mullions  
 at 800 Pa  
 and pressure coefficient: 1.2

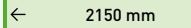

## DUCOWALL ACOUSTIC

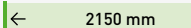
Aluminium louvre wall system with louvre blades that are fitted with **sound-absorbing**, non-combustible mineral wool. Quick assembly with DUCO's patented 'Turn-Click' system.

 DucoWall <b>Acoustic W 75Z</b>	  	 1700 mm	see p. 28
 DucoWall <b>Acoustic W 75L</b>	  	 1650 mm	see p. 28
 DucoWall <b>Acoustic W 150</b>	  	 2150 mm	see p. 29
DucoWall <b>Acoustic W 300</b>	  	 2150 mm	see p. 29

## DUCODOOR LOUVRE DOORS









Ventilated louvre doors or false louvre doors, optionally either integrated or not into the louvre wall.

Duco <b>Door</b> Wall		Louvre door in louvre wall system without specific requirements	see p. 31
Duco <b>Door</b> Louvre		Ventilated <b>louvre door or false louvre door</b> in the louvre wall system with specific requirements for intrusion resistance and/or draught-proofing	see p. 32
Duco <b>Door</b> Grille		<b>Free-standing ventilated louvre door or false louvre door</b> , either with or without specific requirements for intrusion resistance and/or draught-proofing	see p. 33

## ROOF TURRETS

Kits and components to build roof cowls with DucoWall louvre blades.

Duco <b>Roof Turret</b> Solid 30Z	  n/a	see p. 36
-----------------------------------	---	-----------

<b>Legend</b>		<b>Vandal-proof</b> The grille is vandal-proof		<b>Burglary-resistant</b> The grille is (optionally) burglary-resistant up to class 2
		<b>Penetration safe</b> The grille is penetration-proof		<b>Water resistant</b> The grille is <b>good</b> to <b>very good</b> water resistant
		<b>Impact protection</b> Resistant to intense shocks		<b>Sound absorption</b> Can be used in projects with <b>light</b> or <b>heavy (+)</b> noise exposure
		<b>Fall-through protection</b> Prevents people from falling through		<b>High Performance</b> The louvre blades are optimised for high air flow

### LOUVRE GRILLES

Louvre blades with  are also available as wall and/or window louvre grilles (DucoGrille). See our 'Louvre grilles' brochure for more information.





Vandal-proof

# DucoWall Solid W 30Z

DucoWall Solid 30Z louvre blades offer high ventilation capacity with relatively small louvre blades. The 'stackable' louvre blades form a single whole, making them **extra strong** and **vandal-proof**. The strong louvre blade system requires a minimal support structure. DUCO's 'Direct Clip' system ensures **very quick assembly**.

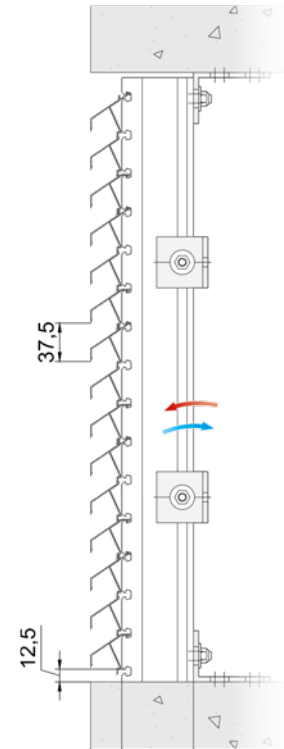

## DIMENSIONS AND MULLIONS

Type of mullion	40/21 (Double)	40/70 Double	40/100 Double
Spacing of the louvre (pitch)	37,5 mm		
Louvre depth	30 mm		
Recess depth	52 mm	102 mm	132 mm
Maximum span between 2 mullions	← 1970 mm →		

## VENTILATION VALUES

Feature		P1		P2	
		STND	+OPT	STND	+OPT
Visual free area		60 %	n/a	86 %	86 %
Physical free area		34 %	n/a	48 %	48 %
Ce (higher is better)		0,216	n/a	0,234	0,232
Cd (higher is better)		0,242	n/a	0,271	0,266
<b>K-FACTOR</b> (lower is better)	INTAKE	21,43	n/a	18,26	18,58
	EXHAUST	17,08	n/a	13,62	14,13

STND and +OPT version: see page 5

## WATER RESISTANCE





Air velocity	Class			
	P1		P2	
	STND	+OPT	STND	+OPT
0 m/s	B	n/a	B	B
0,5 m/s	B	n/a	C	B
1 m/s	C	n/a	C	B
1,5 m/s	C	n/a	C	B
2 m/s	D	n/a	D	C
2,5 m/s	D	n/a	D	D



## Punching

DucoWall Solid W 30Z is available with louvre blades with **small punching (P1)**, **large punching (P2)** or without punching as **false louvres (NP)**. Combining the two in the same project ensures a uniform appearance.

### INSECT SCREEN

Punching			
	P1	P2	NP
Resistant to...	Perforated louvre blades as insect screen	Perforated louvre blades as bird screen  <b>OPTIONS</b> Stainless steel mesh, <b>2.3 x 2.3 mm</b>   Stainless steel mesh, <b>6 x 6 mm</b> 	100 % false louvre

## SUPERFAST ASSEMBLY

DucoWall Solid W 30Z is made up of **triple louvre blades** that are clicked together one above the other onto the mullion using DUCO's 'Direct Clip' system. This ensures a very sturdy unit and extremely quick assembly.

The final row can be finished with a single louvre blade.

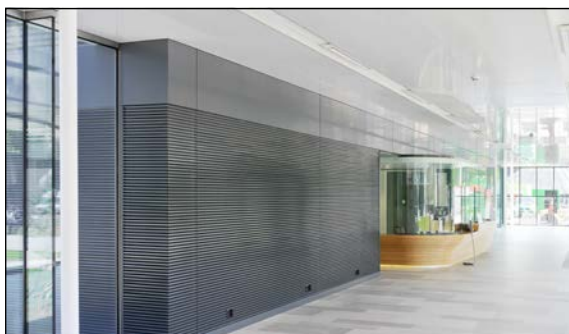
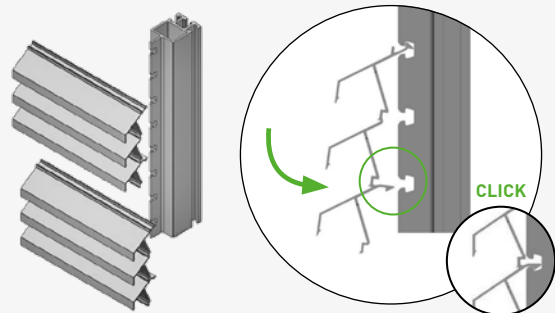

# DUCOWALL SCREENING

An aluminium louvre wall system for screening applications: DucoWall Screening is eminently suitable for projects where the wall acts primarily as **screening**. Assembly is very quick.

Within the Screening range there are two options. **DucoWall Screening 35** adds aesthetic value to your project and guarantees quick installation.

The larger variant is **DucoWall Screening 70**. Benefits include the high span and high airflow. In combination with the limited number of supports, this louvre also ensures very smooth installation of the full louvre wall.

**SUPERFAST  
ASSEMBLY**





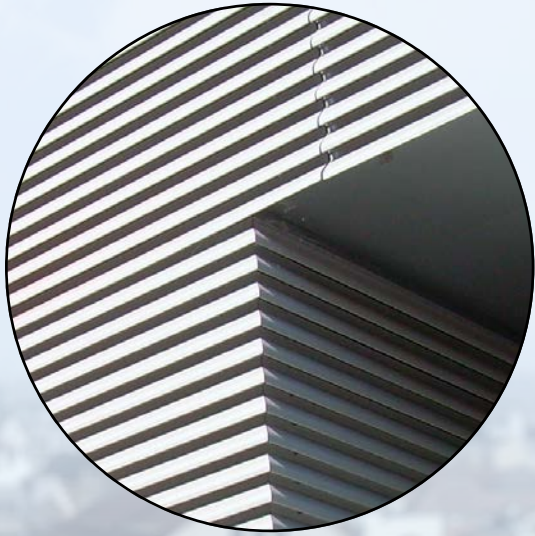

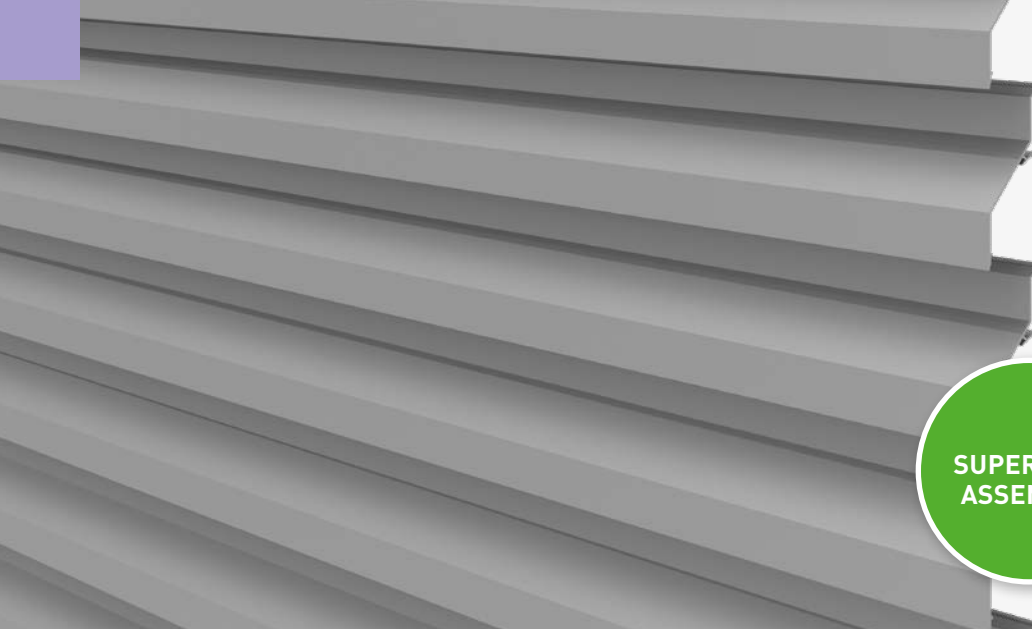

**SUPERFAST ASSEMBLY**

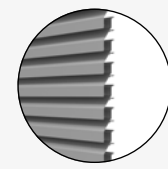

Louvre pitch 75

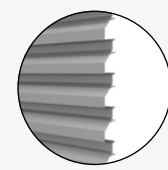

Louvre pitch 112

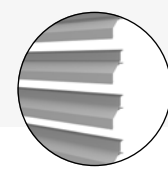

Louvre pitch 150

# DucoWall Screening 35

DucoWall Screening 35 is a louvre wall system that can be clicked directly onto the mullion. This results in **quick and smooth assembly**. There are three different louvre blades to choose from. In this way, the louvre wall can be adapted to the wishes and needs of any project. The system is eminently suitable for projects where the louvre wall acts primarily as **screening**.

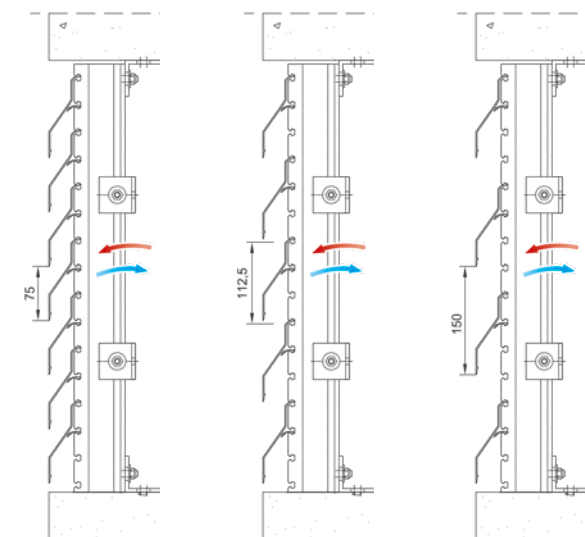

Louvre pitch 75

Louvre pitch 112

Louvre pitch 150

## DIMENSIONS AND MULLIONS

Type of mullion	40/21 (Double)	40/70 Double	40/100 Double
Spacing of the louvre (pitch)	75 mm - 112 mm - 150 mm		
Louvre depth	43 mm		
Recess depth	57 mm	107 mm	137 mm
Maximum span between 2 mullions	← 1650 mm →		

## VENTILATION VALUES

Feature	75		112		150		
	STND	+OPT	STND	+OPT	STND	+OPT	
Visual free area	52 %	52 %	68 %	68 %	76 %	76 %	
Physical free area	29 %	29 %	27 %	27 %	35 %	35 %	
Ce (higher is better)	0,128	0,128	0,122	0,121	0,206	0,204	
Cd (higher is better)	0,162	0,161	0,174	0,175	0,224	0,222	
<b>K-FACTOR</b> (lower is better)	INTAKE	61,04	61,04	67,19	68,30	23,56	24,03
	EXHAUST	38,10	38,58	33,03	32,65	19,93	20,29

STND and +OPT version: see page 5

Insect protection: optional stainless steel mesh 2.3 x 2.3 mm or 6 x 6 mm

## WATER RESISTANCE

Air velocity	Class					
	75		112		150	
	STND	+OPT	STND	+OPT	STND	+OPT
0 m/s	A	A	B	B	C	C
0,5 m/s	B	B	C	B	C	C
1 m/s	B	B	C	C	D	D
1,5 m/s	D	D	D	D	D	D
2 m/s	D	D	D	D	D	D
2,5 m/s	D	D	D	D	D	D



→ Overview of mullions: see page 43  
→ Full specifications: see page 44



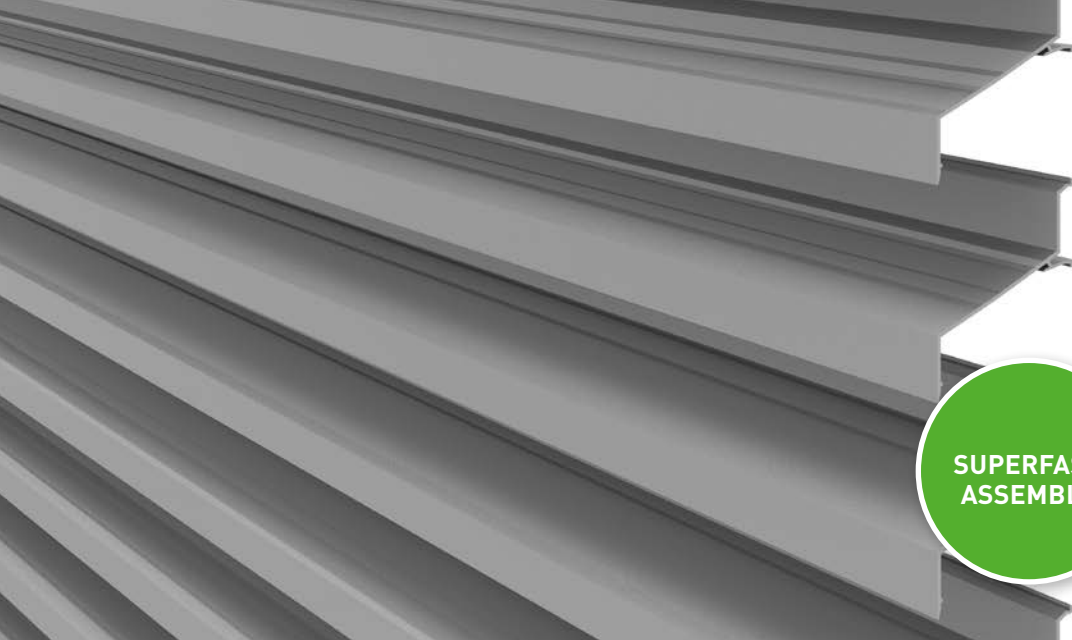

**SUPERFAST ASSEMBLY**

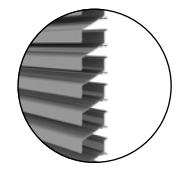

Louvre pitch 75

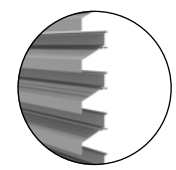

Louvre pitch 112

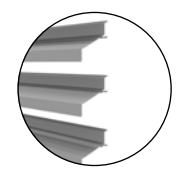

Louvre pitch 150

# DucoWall Screening 70

DucoWall Screening 70 is a louvre wall system with a very **high span** and **high airflow**. The louvre blades are fastened directly onto the mullion (Direct Clip). In combination with the limited number of supports, this ensures a **very fast installation** of the louvre wall. DucoWall Screening 70 is available with different louvre pitches (75 / 112 / 150 mm).

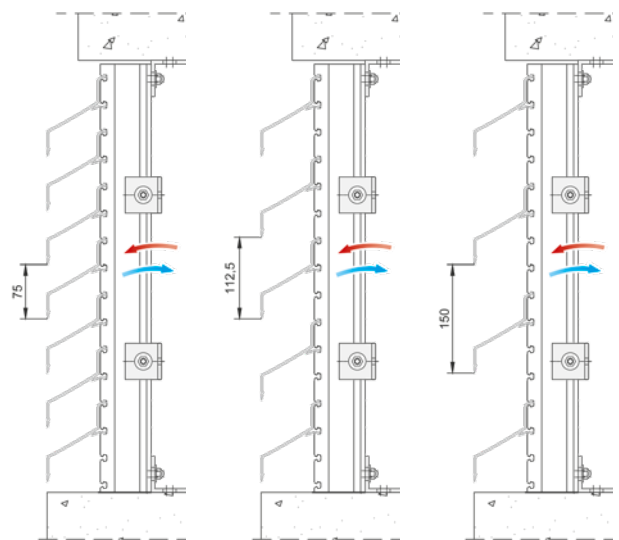

Louvre pitch 75

Louvre pitch 112

Louvre pitch 150

## DIMENSIONS AND MULLIONS

Type of mullion	40/21 (Double)	40/70 Double	40/100 Double
Spacing of the louvre (pitch)	75 mm - 112 mm - 150 mm		
Louvre depth	82 mm		
Recess depth	94,5 mm	145 mm	175 mm
Maximum span between 2 mullions	← 2400 mm →		

## VENTILATION VALUES

Feature	75		112		150		
	STND	+OPT	STND	+OPT	STND	+OPT	
Visual free area	53 %	53 %	68 %	68 %	77 %	77 %	
Physical free area	37 %	37 %	59 %	59 %	55 %	55 %	
Ce (higher is better)	0,182	0,181	0,212	0,212	0,270	0,264	
Cd (higher is better)	0,200	0,197	0,270	0,266	0,313	0,308	
<b>K-FACTOR</b> (lower is better)	INTAKE	30,19	30,52	22,25	22,25	13,72	14,35
	EXHAUST	25,00	25,77	13,72	14,13	10,21	10,54

STND and +OPT version: see page 5

Insect protection: optional stainless steel mesh 2.3 x 2.3 mm or 6 x 6 mm

## WATER RESISTANCE

Air velocity	Class					
	75		112		150	
	STND	+OPT	STND	+OPT	STND	+OPT
0 m/s	B	A	B	B	C	C
0,5 m/s	C	B	C	B	D	C
1 m/s	C	C	C	C	D	D
1,5 m/s	C	C	C	C	D	D
2 m/s	D	D	D	C	D	D
2,5 m/s	D	D	D	D	D	D



→ Overview of mullions: see page 43  
→ Full specifications: see page 44



# DucoWall Classic W 20Z

DucoWall Classic W 20Z is a louvre wall system that can be fitted against a support structure. Quick and easy assembly is possible because of the 'Turn-Click' system. The "Z"-shaped louvre blade produces a sleek design.

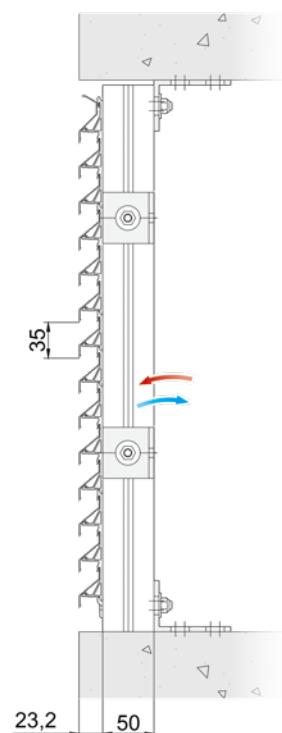

## DIMENSIONS AND MULLIONS

Type of mullion	50/12	21/50 Multi	50/50	50/125
Spacing of the louvre (pitch)	35 mm			
Louvre depth	23 mm			
Recess depth	35 mm	73 mm	73 mm	148 mm
Maximum span between 2 mullions	← 1200 mm →			

## VENTILATION VALUES

Feature		STND	+OPT
Visual free area		63 %	63 %
Physical free area		47 %	47 %
Ce (higher is better)		0,210	0,203
Cd (higher is better)		0,181	0,174
<b>K-FACTOR</b> (lower is better)	INTAKE	22,68	24,27
	EXHAUST	30,52	33,03

## WATER RESISTANCE

Air velocity	Class	
	STND	+OPT
0 m/s	C	B
0,5 m/s	C	B
1 m/s	D	C
1,5 m/s	D	D
2 m/s	D	D
2,5 m/s	D	D

STND and +OPT version: see page 5    Insect protection: optional stainless steel mesh 2.3 x 2.3 mm or 6 x 6 mm



→ Overview of mullions: see page 43  
→ Full specifications: see page 44



Good water resistance



Penetration safe

# DucoWall Classic W 20V

DucoWall Classic W 20V is a louvre wall system that can be fitted against a support structure. Quick and easy assembly is possible because of the 'Turn-Click' system. The unique **"V"-shaped louvre blade** ensures better water resistance and makes the louvre wall 'penetration-proof' and difficult to see through from the outside.

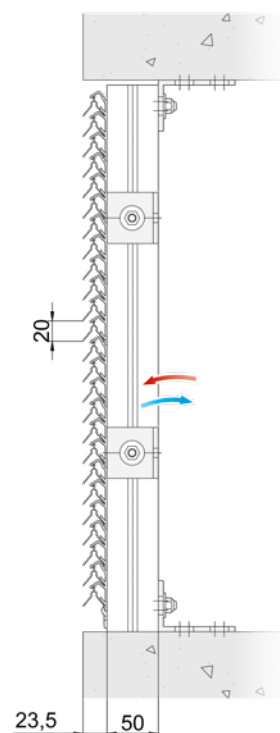

## DIMENSIONS AND MULLIONS

Type of mullion	50/12	21/50 Multi	50/50	50/125
Spacing of the louvre (pitch)	20 mm			
Louvre depth	23 mm			
Recess depth	35 mm	73 mm	73 mm	148 mm
Maximum span between 2 mullions	← 1850 mm →			

## VENTILATION VALUES

Feature		STND	+OPT
Visual free area		95 %	95 %
Physical free area		37 %	37 %
Ce (higher is better)		0,155	0,149
Cd (higher is better)		0,155	0,149
<b>K-FACTOR</b> (lower is better)	INTAKE	41,62	45,04
	EXHAUST	41,62	45,04

STND and +OPT version: see page 5

Insect protection: optional stainless steel mesh 2.3 x 2.3 mm or 6 x 6 mm

## WATER RESISTANCE

Air velocity	Class	
	STND	+OPT
0 m/s	A	A
0,5 m/s	B	A
1 m/s	C	B
1,5 m/s	D	B
2 m/s	D	C
2,5 m/s	D	D



MORE  
INFO

→ Overview of mullions: see page 43  
→ Full specifications: see page 44



Good water resistance



Penetration safe

# DucoWall Classic W 35V

DucoWall Classic W 35V is a louvre wall system that can be fitted against a support structure. Quick and easy assembly is possible because of the 'Turn-Click' system. The unique **"V"-shaped louvre blade** ensures better water resistance and makes the louvre wall 'penetration-proof' and difficult to see through from the outside.

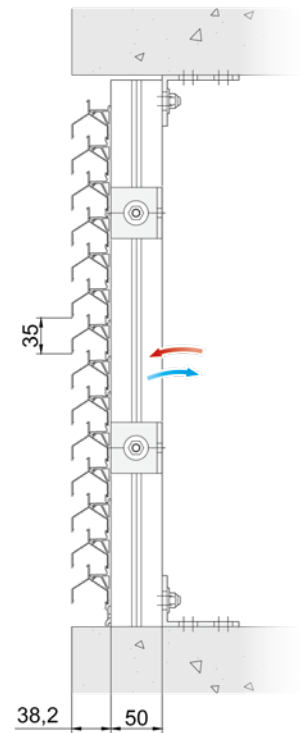

## DIMENSIONS AND MULLIONS

Type of mullion	50/12	21/50 Multi	50/50	50/125
Spacing of the louvre (pitch)	35 mm			
Louvre depth	38 mm			
Recess depth	50 mm	88 mm	88 mm	163 mm
Maximum span between 2 mullions	← 2650 mm →			

## VENTILATION VALUES

Feature		STND	+OPT
Visual free area		59 %	59 %
Physical free area		35 %	35 %
Ce (higher is better)		0,118	0,116
Cd (higher is better)		0,124	0,123
<b>K-FACTOR</b> (lower is better)	INTAKE	71,82	74,32
	EXHAUST	65,04	66,10

## WATER RESISTANCE

Air velocity	Class	
	STND	+OPT
0 m/s	A	A
0,5 m/s	A	A
1 m/s	A	A
1,5 m/s	A	A
2 m/s	C	B
2,5 m/s	C	C

STND and +OPT version: see page 5

Insect protection: optional stainless steel mesh 2.3 x 2.3 mm or 6 x 6 mm



→ Overview of mullions: see page 43  
→ Full specifications: see page 44





# DucoWall Classic W 50Z/30°

DucoWall Classic W 50Z/30° is a louvre wall system that can be fitted against a support structure. Quick and easy assembly is possible because of the 'Turn-Click' system. The "Z"-shaped louvre blade produces a sleek design. The louvre wall is available with 65 or 75 mm spacing.

## DIMENSIONS AND MULLIONS

Type of mullion	50/12	21/50 Multi	50/50	50/125
Spacing of the louvre (pitch)	65 or 75 mm			
Louvre depth	53 mm			
Recess depth	65 mm	103 mm	103 mm	178 mm
Maximum span between 2 mullions	← 2050 mm →			

## VENTILATION VALUES

Feature		65		75	
		STND	+OPT	STND	+OPT
Visual free area		41 %	41 %	49 %	49 %
Physical free area		40 %	40 %	46 %	46 %
Ce (higher is better)		0,262	0,253	0,312	0,310
Cd (higher is better)		0,308	0,302	0,339	0,336
<b>K-FACTOR</b> (lower is better)	INTAKE	14,57	15,62	10,27	10,41
	EXHAUST	10,54	10,96	8,70	8,86

STND and +OPT version: see page 5

Insect protection: optional stainless steel mesh 2.3 x 2.3 mm or 6 x 6 mm

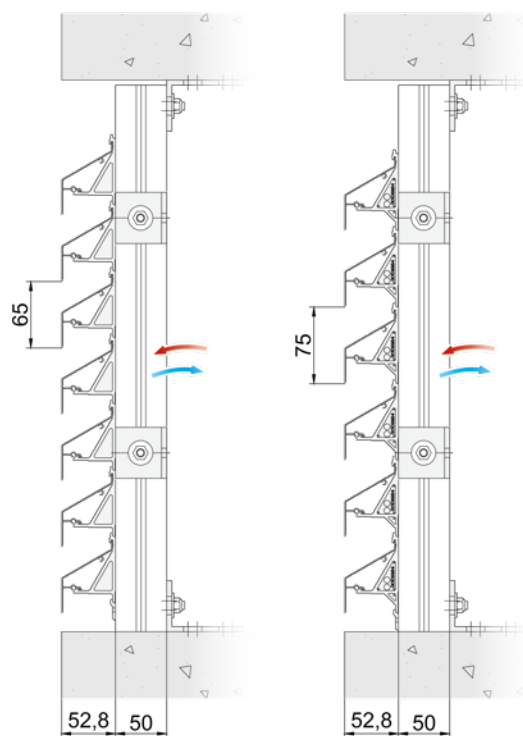

Louvre pitch 65

Louvre pitch 75

## WATER RESISTANCE

Air velocity	Class			
	65		75	
	STND	+OPT	STND	+OPT
0 m/s	B	A	B	B
0,5 m/s	C	B	C	B
1 m/s	C	B	C	C
1,5 m/s	C	C	C	C
2 m/s	D	C	D	C
2,5 m/s	D	C	D	D



# DucoWall Classic W 50Z

DucoWall Classic W 50Z is a louvre wall system that can be placed against a support structure. Quick and easy assembly is possible because of the 'Turn-Click' system. The "Z"-shaped louvre blade produces a sleek design.

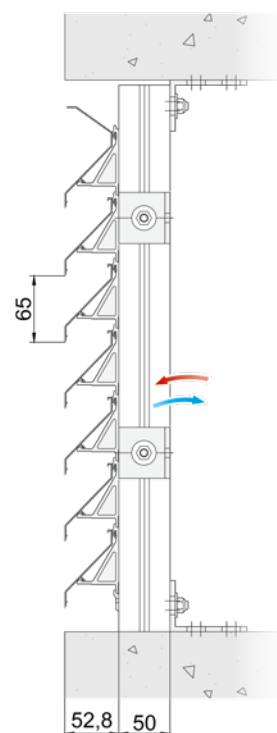

## DIMENSIONS AND MULLIONS

Type of mullion	50/12	21/50 Multi	50/50	50/125
Spacing of the louvre (pitch)	65 mm			
Louvre depth	53 mm			
Recess depth	65 mm	103 mm	103 mm	178 mm
Maximum span between 2 mullions	← 1550 mm →			

## VENTILATION VALUES

Feature		STND	+OPT
Visual free area		75 %	75 %
Physical free area		52 %	52 %
Ce (higher is better)		0,205	0,207
Cd (higher is better)		0,278	0,266
<b>K-FACTOR</b> (lower is better)	INTAKE	23,80	23,34
	EXHAUST	12,94	14,13

## WATER RESISTANCE

Air velocity	Class	
	STND	+OPT
0 m/s	B	A
0,5 m/s	C	B
1 m/s	C	B
1,5 m/s	C	C
2 m/s	D	C
2,5 m/s	D	D

STND and +OPT version: see page 5     Insect protection: optional stainless steel mesh 2.3 x 2.3 mm or 6 x 6 mm



# DucoWall Classic W 50/75Z

DucoWall Classic W 50/75Z is a louvre wall system that can be fitted against a support structure. Quick and easy assembly is possible because of the 'Turn-Click' system. The "Z"-shaped louvre blade produces a sleek design.

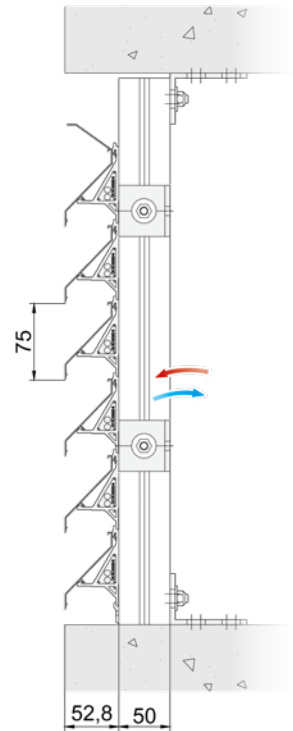

## DIMENSIONS AND MULLIONS

Type of mullion	50/12	21/50 Multi	50/50	50/125
Spacing of the louvre (pitch)	75 mm			
Louvre depth	53 mm			
Recess depth	65 mm	103 mm	103 mm	178 mm
Maximum span between 2 mullions	← 1550 mm →			

## VENTILATION VALUES

Feature		STND	+OPT
Visual free area		80 %	80 %
Physical free area		54 %	54 %
Ce (higher is better)		0,219	0,219
Cd (higher is better)		0,297	0,288
<b>K-FACTOR</b> (lower is better)	INTAKE	20,85	20,85
	EXHAUST	11,34	12,06

## WATER RESISTANCE

Air velocity	Class	
	STND	+OPT
0 m/s	B	A
0,5 m/s	C	B
1 m/s	C	B
1,5 m/s	D	C
2 m/s	D	C
2,5 m/s	D	D

STND and +OPT version: see page 5 Insect protection: optional stainless steel mesh 2.3 x 2.3 mm or 6 x 6 mm



→ Overview of mullions: see page 43  
→ Full specifications: see page 44



Good water resistance



Penetration safe

# DucoWall Classic W 70V

DucoWall Classic W 70V is a louvre wall system that can be fitted against an existing structure. Quick and easy assembly is possible because of the 'Turn-Click' system. The unique **"V"-shaped louvre blade** ensures better water resistance and makes the louvre wall 'penetration-proof' and difficult to see through from the outside.

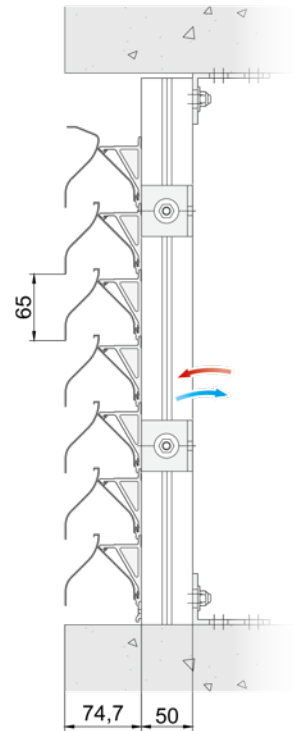

## DIMENSIONS AND MULLIONS

Type of mullion	50/12	21/50 Multi	50/50	50/125
Spacing of the louvre (pitch)	65 mm			
Louvre depth	75 mm			
Recess depth	87 mm	125 mm	125 mm	200 mm
Maximum span between 2 mullions	← 2150 mm →			

## VENTILATION VALUES

Feature		STND	+OPT
Visual free area		65 %	65 %
Physical free area		44 %	44 %
Ce (higher is better)		0,117	0,111
Cd (higher is better)		0,109	0,103
<b>K-FACTOR</b> (lower is better)	INTAKE	73,05	81,16
	EXHAUST	84,17	94,26

## WATER RESISTANCE

Air velocity	Class	
	STND	+OPT
0 m/s	B	A
0,5 m/s	B	B
1 m/s	B	B
1,5 m/s	C	C
2 m/s	D	D
2,5 m/s	D	D

STND and +OPT version: see page 5

Insect protection: optional stainless steel mesh 2.3 x 2.3 mm or 6 x 6 mm



→ Overview of mullions: see page 43  
→ Full specifications: see page 44





High Performance

# DucoWall Classic W 45HP

The DucoWall Classic W 45HP combines **very good airflow** with a **“Z”-shaped louvre blade** for a sleek design. This makes the DucoWall Classic W 45HP suitable for purge ventilation in projects with specific aesthetic requirements.

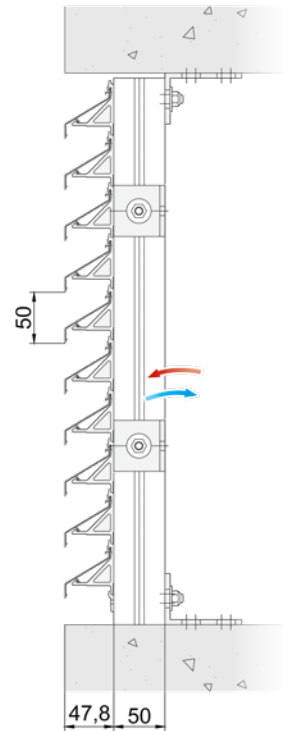

## DIMENSIONS AND MULLIONS

Type of mullion	50/12	21/50 Multi	50/50	50/125
Spacing of the louvre (pitch)	50 mm			
Louvre depth	48 mm			
Recess depth	60 mm	98 mm	98 mm	173 mm
Maximum span between 2 mullions	← 1330 mm →			
Louvre blade holders	Plastic Metal Clip <small>Reaction to fire A2-s1,d0 (EN13501-1)</small>			

## VENTILATION VALUES

Feature		STND	+OPT
Visual free area		70 %	70 %
Physical free area		60 %	60 %
Ce (higher is better)		0,295	0,295
Cd (higher is better)		0,385	0,369
<b>K-FACTOR</b> <small>(lower is better)</small>	INTAKE	11,49	11,49
	EXHAUST	6,75	7,34

## WATER RESISTANCE

Air velocity	Class	
	STND	+OPT
0 m/s	C	B
0,5 m/s	C	B
1 m/s	C	C
1,5 m/s	C	C
2 m/s	D	C
2,5 m/s	D	C

STND and +OPT version: see page 5    Insect protection: optional stainless steel mesh 2.3 x 2.3 mm or 6 x 6 mm



→ Overview of mullions: see page 43  
→ Full specifications: see page 44

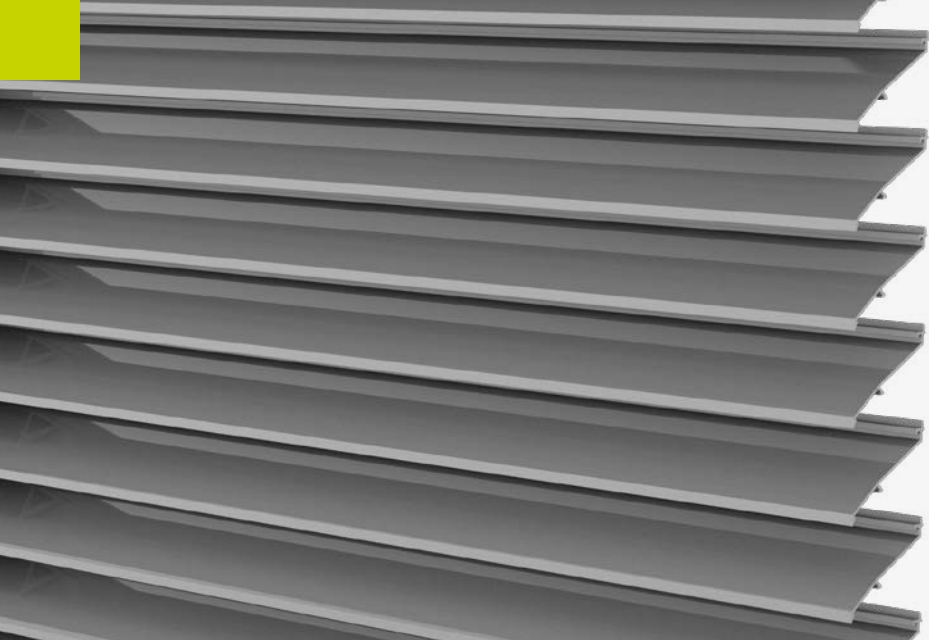

High Performance

**Very high airflow**

K-FACTOR INTAKE **7.80**

K-FACTOR EXHAUST **5.19**

# DucoWall Classic W 50HP

The DucoWall Classic W 50HP has been specially developed for **purge ventilation**. The uniquely shaped 'High Performance' louvre blade with a low resistance factor ensures **very good airflow**. The DucoWall Classic W 50HP is a louvre wall system that can be fitted against an existing structure. Quick and easy assembly is possible because of the 'Turn-Click' system.

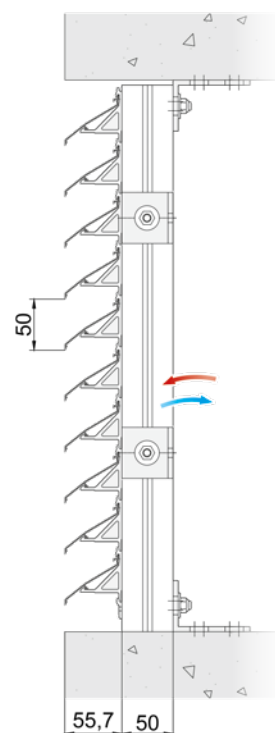

## DIMENSIONS AND MULLIONS

Type of mullion	50/12	21/50 Multi	50/50	50/125
Spacing of the louvre (pitch)	50 mm			
Louvre depth	56 mm			
Recess depth	68 mm	106 mm	106 mm	181 mm
Maximum span between 2 mullions	← 1100 mm →			
Louvre blade holders	Plastic Metal Clip Reaction to fire A2-s1,d0 (EN13501-1)			

## VENTILATION VALUES

Feature	STND	+OPT	
Visual free area	88 %	88 %	
Physical free area	68 %	68 %	
Ce (higher is better)	<b>0,358</b>	<b>0,352</b>	
Cd (higher is better)	<b>0,439</b>	<b>0,415</b>	
<b>K-FACTOR</b> (lower is better)	INTAKE	<b>7,80</b>	<b>8,07</b>
	EXHAUST	<b>5,19</b>	<b>5,81</b>

## WATER RESISTANCE

Air velocity	Class	
	STND	+OPT
0 m/s	C	B
0,5 m/s	C	B
1 m/s	C	B
1,5 m/s	D	C
2 m/s	D	C
2,5 m/s	D	C

STND and +OPT version: see page 5     Insect protection: optional stainless steel mesh 2.3 x 2.3 mm or 6 x 6 mm



High Performance



Excellent water resistance



Fall-through protection



Impact protection



# DucoWall Classic W 130HP

The DucoWall Classic W 130HP has been specially developed for **purge ventilation**. The uniquely shaped 'High Performance' louvre blade with a low resistance factor provides a combination of **very good airflow** (high flow rates) together with **excellent water resistance (class A)**. DucoWall Classic W 130HP is a louvre wall system that can be fitted against an existing structure. Quick and easy assembly is possible because of the 'Turn-Click' system. The DucoWall Classic W 130HP meets class 5 of EN13049 for **impact protection\*** and BS6180 standard (class XI) for **fall-through protection\***. See page 38-39 for all classes per country.

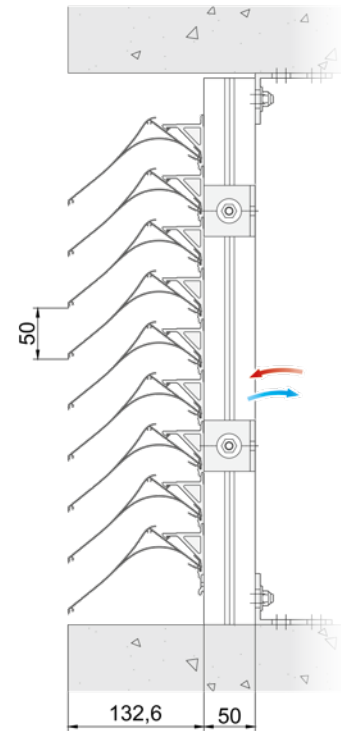

## DIMENSIONS AND MULLIONS

Type of mullion	50/12	21/50 Multi	50/50	50/125
Spacing of the louvre (pitch)	50 mm			
Louvre depth	133 mm			
Recess depth	145 mm	183 mm	183 mm	258 mm
Maximum span between 2 mullions	← 2300 mm →			
Louvre blade holders	Plastic Metal Clip <small>Reaction to fire A2-s1,d0 (EN13501-1)</small>			

## VENTILATION VALUES

Feature		STND	+OPT
Visual free area		88 %	n/a
Physical free area		70 %	n/a
Ce (higher is better)		0,327	n/a
Cd (higher is better)		0,295	n/a
<b>K-FACTOR</b> <small>(lower is better)</small>	INTAKE	9,35	n/a
	EXHAUST	11,49	n/a

STND and +OPT version: see page 5 Insect protection: optional stainless steel mesh 2.3 x 2.3 mm or 6 x 6 mm

\* Impact and fall protection only applies in combination with Metal Clips.

## WATER RESISTANCE

Air velocity	Class	
	STND	+OPT
0 m/s	A	n/a
0,5 m/s	A	n/a
1 m/s	A	n/a
1,5 m/s	A	n/a
2 m/s	A	n/a
2,5 m/s	C	n/a



→ Overview of mullions: see page 43  
→ Full specifications: see page 44

→ Impact & fall-through protection: see page 38-39



# DucoWall Classic W 80HP

DucoWall Classic W 80HP is a louvre wall system that can be fitted against an existing structure. Quick and easy assembly is possible because of the 'Turn-Click' system. The uniquely shaped 'High Performance' louvre blade provides **good water resistance** and **high airflow**.

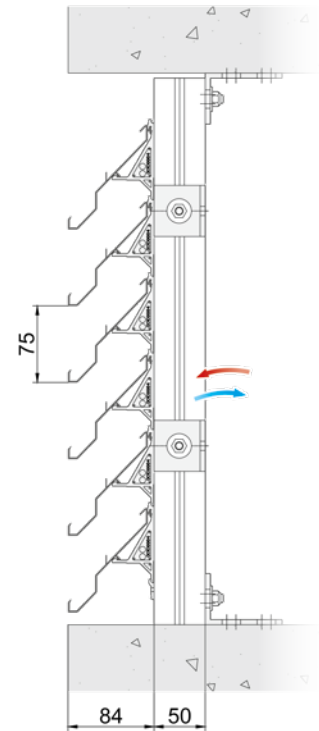

## DIMENSIONS AND MULLIONS

Type of mullion	50/12	21/50 Multi	50/50	50/125
Spacing of the louvre (pitch)	75 mm			
Louvre depth	84 mm			
Recess depth	96 mm	134 mm	134 mm	209 mm
Maximum span between 2 mullions	← 1350 mm →			

## VENTILATION VALUES

Feature		STND	+OPT
Visual free area		83 %	83 %
Physical free area		49 %	49 %
Ce (higher is better)		0,299	0,284
Cd (higher is better)		0,271	0,256
<b>K-FACTOR</b> (lower is better)	INTAKE	11,19	12,40
	EXHAUST	13,62	15,26

## WATER RESISTANCE

Air velocity	Class	
	STND	+OPT
0 m/s	A	A
0,5 m/s	B	B
1 m/s	B	C
1,5 m/s	C	C
2 m/s	C	C
2,5 m/s	D	D

STND and +OPT version: see page 5     Insect protection: optional stainless steel mesh 2.3 x 2.3 mm or 6 x 6 mm

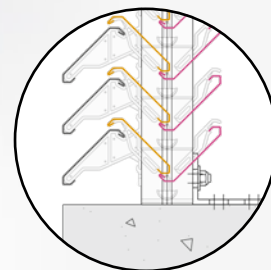

**W 60C/3**  
triple row of louvre blades

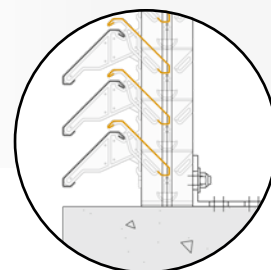

**W 60C/2**  
double row of louvre blades

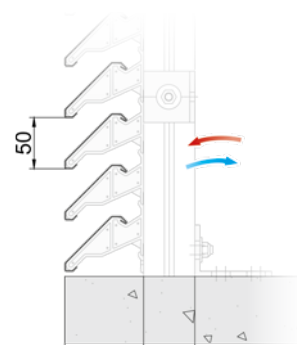

**W 60C**  
single row of louvre blades

# DucoWall Classic W 60C

DucoWall Classic W 60C is a 'feature' louvre wall system, manufactured from 'cold-rolled' rather than extruded, aluminium louvre blades. The plastic louvre holders ensure a unique sturdiness. The three versions (**single, double or triple**) combine maximum airflow with **very high water resistance**, even in extreme weather conditions.

## DIMENSIONS AND MULLIONS

Type of mullion		50/12	21/50 Multi	50/50	50/125
Spacing of the louvre (pitch)		50 mm			
Louvre depth		77 mm			
Recess depth	60C	89 mm	127 mm	127 mm	202 mm
	60C/2	x			
	60C/3				
Maximum span between 2 mullions		← 1250 mm →			

## VENTILATION VALUES

Feature	60C		60C/2		60C/3		
	STND	+OPT	STND	+OPT	STND	+OPT	
Visual free area	84 %	84 %	84 %	84 %	84 %	84 %	
Physical free area	46 %	46 %	36 %	36 %	36 %	36 %	
Ce (higher is better)	0,315	0,300	0,208	0,202	0,179	0,175	
Cd (higher is better)	0,305	0,291	0,196	0,191	0,153	0,151	
<b>K-FACTOR</b> (lower is better)	INTAKE	10,08	11,11	23,11	24,51	31,21	32,65
	EXHAUST	10,75	11,81	26,03	27,41	42,72	43,86

STND and +OPT version: see page 5

Insect protection: optional stainless steel mesh 2.3 x 2.3 mm or 6 x 6 mm

## WATER RESISTANCE

Air velocity	Class					
	60C		60C/2		60C/3	
	STND	+OPT	STND	+OPT	STND	+OPT
0 m/s	B	B	A	A	A	A
0,5 m/s	C	C	A	A	A	A
1 m/s	C	C	B	B	A	A
1,5 m/s	D	D	C	C	A	A
2 m/s	D	D	C	C	A	A
2,5 m/s	D	D	C	C	C	C



→ Overview of mullions: see page 43  
→ Full specifications: see page 44





## DucoWall **Solid 30Z**

Umicore | Hoboken (Belgium)







Suitable for moderate noise levels

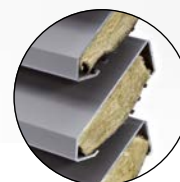

W 75Z

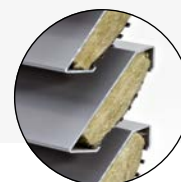

W 75L

# DucoWall **Acoustic** W 75Z & 75L

The DucoWall Acoustic W 75Z and W 75L are **sound-absorbing** louvre wall systems, manufactured from extruded aluminium sections profiles that feature sound absorbing, non-combustible mineral wool. The louvre blade can be clicked onto the plastic louvre holders **in both the Z-shape and the L-shape** for different aesthetic finishes.

## DIMENSIONS AND MULLIONS

Type of mullion		50/12	21/50 Multi	50/50	50/125
Spacing of the louvre (pitch)		60 mm			
Louvre depth		67 mm			
Recess depth	75Z	79 mm	117 mm	117 mm	192 mm
	75L	87 mm	125 mm	125 mm	200 mm
Maximum span between 2 mullions	75Z	← 1700 mm →			
	75L	← 1650 mm →			

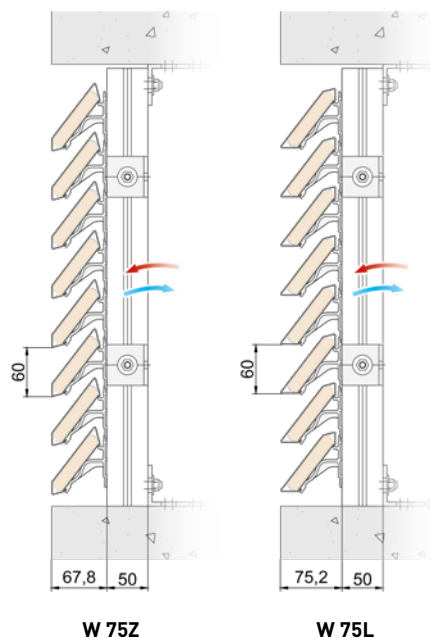

W 75Z

W 75L

## SOUND ABSORPTION

Attenuation value $R_w$ (C;Ctr)	
W 75Z	W 75L
6 (0;-1) dB	6 (0;-2) dB

## VENTILATION VALUES

Feature		75Z		75L	
		STND	+OPT	STND	+OPT
Visual free area		76 %	76 %	95 %	95 %
Physical free area		28 %	28 %	28 %	28 %
Ce (higher is better)		0,196	0,196	0,212	0,209
Cd (higher is better)		0,183	0,182	0,258	0,254
<b>K-FACTOR</b> (lower is better)	INTAKE	26,03	26,03	22,25	22,89
	EXHAUST	29,86	30,19	15,02	15,50

STND and +OPT version: see page 5

Insect protection: optional stainless steel mesh 2.3 x 2.3 mm or 6 x 6 mm

## WATER RESISTANCE

Air velocity	Class			
	75Z		75L	
	STND	+OPT	STND	+OPT
0 m/s	B	B	B	B
0,5 m/s	B	B	B	B
1 m/s	C	C	C	C
1,5 m/s	C	C	D	D
2 m/s	D	D	D	D
2,5 m/s	D	D	D	D



→ Overview of mullions: see page 43  
→ Full specifications: see page 44



Suitable for high noise levels



W 150

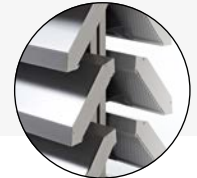

W 300

# DucoWall Acoustic W 150 & 300

The DucoWall Acoustic W 150 is a sound absorbing louvre wall system, manufactured from extruded aluminium sections featuring sound-absorbing, non-combustible mineral wool, suitable for **additional acoustic damping**. With the DucoWall Acoustic W 300, two 150 louvre blades are fitted next to each other for optimum sound absorption.

## DIMENSIONS AND MULLIONS

Type of mullion		50/12	21/50 Multi	50/50	50/125
Spacing of the louvre (pitch)		150 mm			
Louvre depth		142 mm			
Recess depth	150	154 mm	192 mm	192 mm	267 mm
	300				x
Maximum span between 2 mullions		← 2150 mm →			

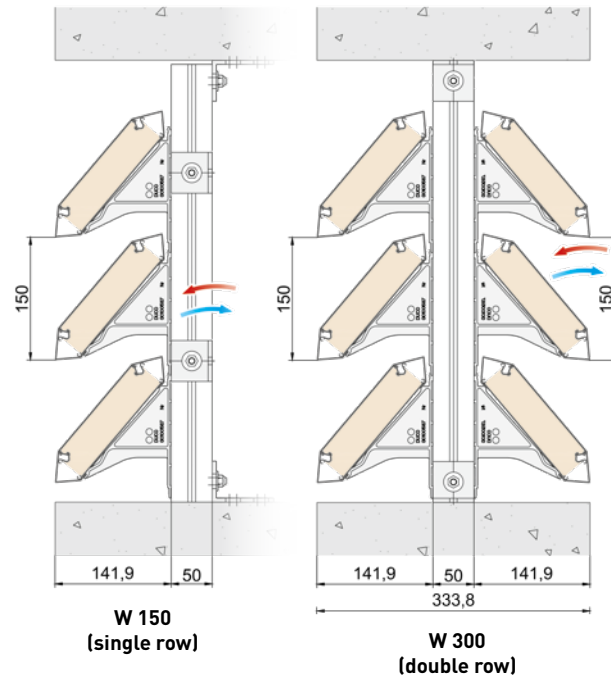

## SOUND ABSORPTION

Attenuation value $R_w$ (C;Ctr)	
W 150	W 300
11 (-1;-2) dB	17 (-1;-3) dB

## VENTILATION VALUES

Feature		150		300	
		STND	+OPT	STND	+OPT
Visual free area		74 %	74 %	74 %	74 %
Physical free area		35 %	35 %	35 %	35 %
Ce (higher is better)		0,301	0,295	0,272	0,250
Cd (higher is better)		0,302	0,296	0,272	0,250
K-FACTOR (lower is better)	INTAKE	11,04	11,49	13,52	16,00
	EXHAUST	10,96	11,41	13,52	16,00











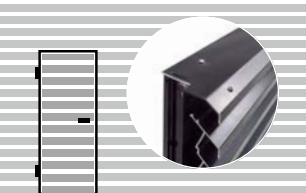





## WATER RESISTANCE

Air velocity	Class			
	150		300	
	STND	+OPT	STND	+OPT
0 m/s	B	B	A	A
0,5 m/s	C	C	B	B
1 m/s	C	C	B	B
1,5 m/s	C	C	C	C
2 m/s	D	D	C	C
2,5 m/s	D	D	D	D

STND and +OPT version: see page 5 Insect protection: optional stainless steel mesh 2.3 x 2.3 mm or 6 x 6 mm

# DUCO LOUVRE DOORS

The louvre door range enables you to choose between the **DucoDoor Wall**, **DucoDoor Louvre** and **DucoDoor Grille** depending on the aesthetic, technical and legal requirements of the building. DUCO's louvre doors are suitable for use in (technical) rooms – whether or not at ground level, in car parks, etc. either **ventilating** or as (draught-proof) **false louvre doors**. All of our doors will guarantee a **sleek and uniform look**.

Type	 <b>DucoDoor Wall</b> see p. 31	 <b>DucoDoor Louvre</b> see p. 32	 <b>DucoDoor Grille</b> see p. 33
<b>Application</b>	Louvre door in louvre wall system without specific requirements.	Ventilated louvre door or false louvre door in the louvre wall system with specific requirements for burglary resistance and/or draught-proofing.	Free-standing ventilated louvre door or false louvre door either with or without specific requirements for burglary resistance and/or draught-proofing.
<b>Vandal-proof</b> 	 Subject to Solid 30Z louvre blades	 Subject to Solid 30Z louvre blades	
<b>Burglary-resistant</b> 		 RC2 possible with NP or P1 internal louvre blades	 RC2 possible with NP or P1 blades
<b>Draught-proof</b>		 Possible subject to NP louvre blades	 Possible subject to NP louvre blades
<b>Louvre blades</b>	Complete DucoWall range possible	Complete DucoWall range available as surface-mounted blades, combined with Solid 30Z internal blades as an option	Solid 30Z NP, P1 or P2 louvre blades
<b>Opening angle</b>			
<b>Available versions</b>	Single / double door   opening inwards / outwards   left / right-hand opening available		
<b>Maximum usable dimensions</b>	Single door: W 1500 x H 3000 mm   Double door: W 3000 x H 3000 mm		
<b>Door furniture</b>	Comes with a lever handle on the inside of the door and a T-handle on the outside as standard. Other combinations available on request. Panic lock available on doors that act as an emergency exit (only for doors less than 2.2 m high, outward opening and not on intrusion-resistant doors).		





# DucoDoor Wall

The DucoDoor Wall is a **pivot door** that can be easily constructed using the same louvre blades and sections as your chosen louvre wall. Thanks to a wide range of Solid, Classic and Screening louvre blades, the DucoDoor Wall integrates seamlessly and **invisibly into a full louvre wall**. This guarantees a sleek and **uniform façade**.

Single door opening **inwards**

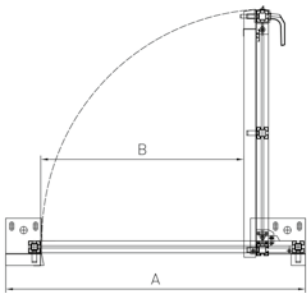

Single door opening **outwards**

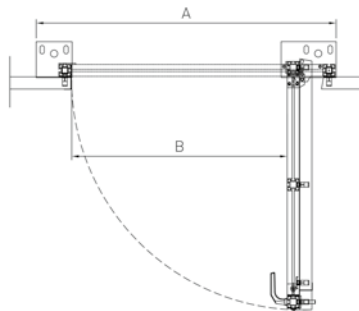

Double door opening **outwards**

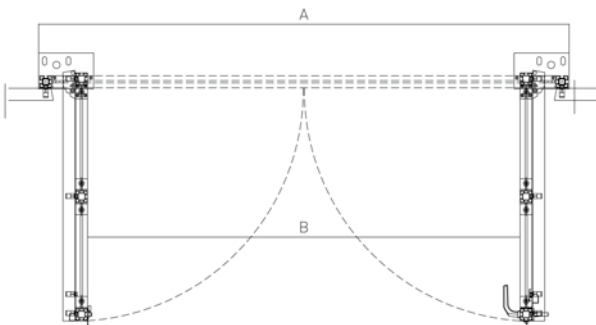

A = overall dimension  
B = useful width

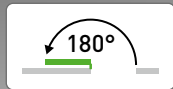
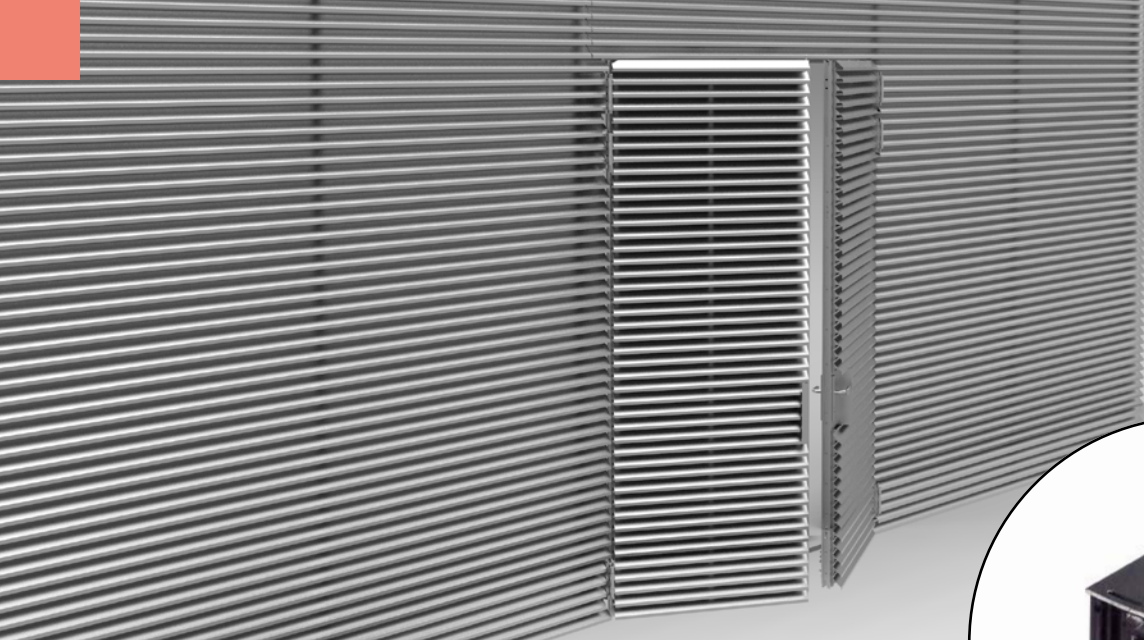

also in  
**RC2**  
configuration

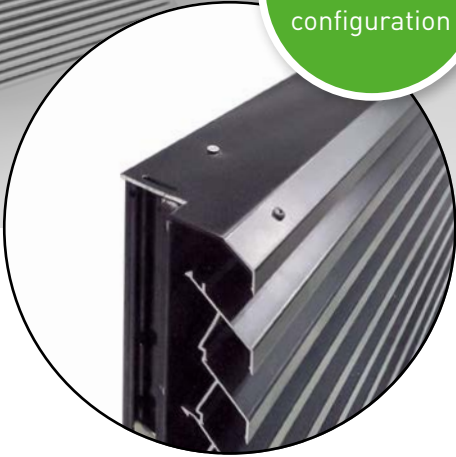

## Duco**Door** Louvre

With the DucoDoor Louvre, DUCO has developed an **intrusion-resistant louvre door** that has been extensively tested by SKG in accordance with European standards (EN 1627:2011 & NEN 5096+C2:2011) and has been certified as **resistance class RC2**. The DucoDoor Louvre can also be made **draughtproof**. The special hinges fitted on the side create a **large usable width** and enable the door to be opened **by 180°**. This type of louvre door can be easily concealed in a louvre wall as it can draw on the **complete range** of Solid, Classic and Screening louvre blades.

Single door  
opening **outwards**

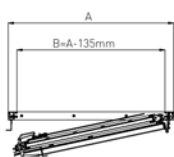

Double door  
opening **inwards**

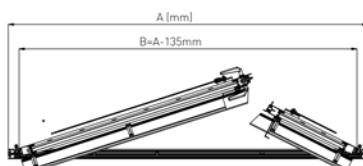
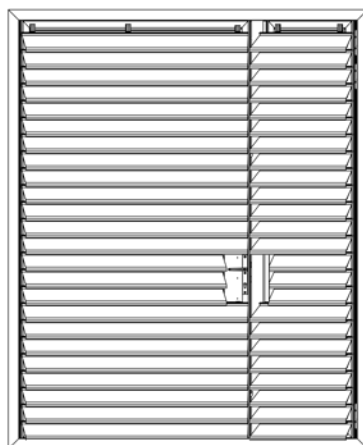

A = overall dimension  
B = useful width

**BURGLARY-  
RESISTANT**

**DucoDoor Louvre** can be ordered up to intrusion-resistance class RC2 as an option. Certification available upon request.



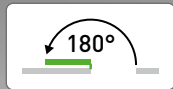

# DucoDoor Grille

As a **free-standing entrance door**, the DucoDoor Grille is eminently suitable for non-louvre walls. Thanks to the fact that the **Solid blades built in as standard** (type 30Z) can be slotted in three different ways, (P1, P2 or NP), the façade can be given an aesthetic and expressive character. The DucoDoor Grille also scores high on **burglary resistance**. The Solid blades make every version **vandal-proof**. What is more, this louvre door has been tested by SKG in accordance with European standards (EN 1627:2011 & NEN 5096+C2:2011) and an **RC2-certified version** is available. In addition, the DucoDoor Grille can be made completely **draught-proof**. The special hinges fitted on the side create a **large usable width** and enable the door to be opened **by 180°**.

Single door opening **inwards**

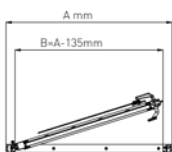

Double door opening **outwards**

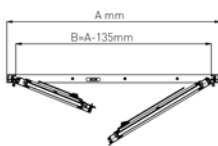
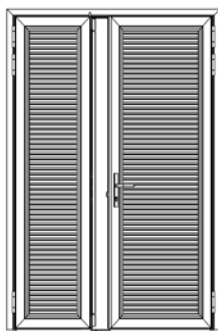

A = overall dimension  
B = useful width

## BURGLARY-RESISTANT

DucoDoor Grille can be ordered up to intrusion-resistance class RC2 as an option. Certification available upon request.



## SPECIFICATIONS

DucoDoor Grille uses Solid 30Z louvre blades. All specifications relating to ventilation capacity, water-resistance and insect-resistance can be found on page 8.





## DucoWall **Classic** 45HP

Data Centre | London (England)









## Duco **Roof Turret** Solid 30Z

Duco Roof Turret Solid 30Z is an aluminium roof cowl. It provides aesthetic concealment of air vents. The roof cowl also ensures adequate **purge ventilation** of the screened areas and can be used in almost **any project**. The perforated Solid 30Z louvre blades are the ideal solution for both insect resistance and ventilation capacity. Thanks to large punching (P2), this **small roof cowl** achieves **high ventilation values**. The roof cowls are **made to measure** and provided with a sill at the bottom and a cover plate on top.

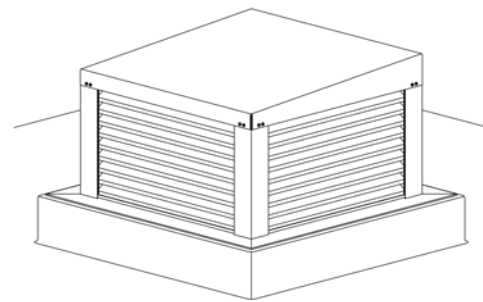

### DIMENSIONS

<b>Spacing of the louvre (pitch)</b>	37,5 mm
<b>Roof cowl length</b>	Min. 200 mm - Max. 2630 mm (to be coupled)
<b>Roof cowl width</b>	Min. 200 mm - Max. 1180 mm (to be coupled)
<b>Roof cowl height</b>	Min. 255 mm - max. 1600 mm

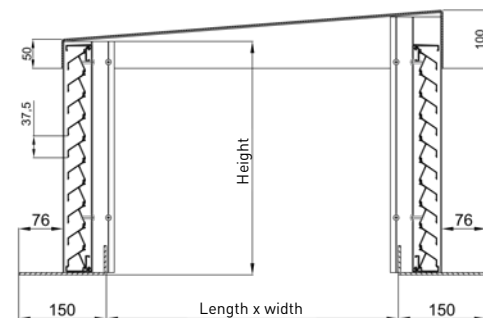

### VENTILATION VALUES

Feature		P1	P2	P2 + ECG
		STND	STND	STND
<b>Visual free area</b>		60 %	86 %	86 %
<b>Physical free area</b>		34 %	48 %	48 %
<b>Ce</b> (higher is better)		<b>0,243</b>	<b>0,258</b>	<b>0,179</b>
<b>Cd</b> (higher is better)		<b>0,234</b>	<b>0,253</b>	<b>0,202</b>
<b>K-FACTOR</b> (lower is better)	INTAKE	<b>16,94</b>	<b>15,02</b>	<b>31,21</b>
	EXHAUST	<b>18,26</b>	<b>15,62</b>	<b>24,51</b>

STND and +OPT version: see page 5

\*ECG = Eggcrate grille (see page 37)

### WATER RESISTANCE

Air velocity	Class		
	P1	P2	P2 + ECG
	STND	STND	STND
0 m/s	<b>B</b>	<b>C</b>	<b>A</b>
0,5 m/s	<b>C</b>	<b>C</b>	<b>A</b>
1 m/s	<b>C</b>	<b>C</b>	<b>A</b>
1,5 m/s	<b>D</b>	<b>D</b>	<b>B</b>
2 m/s	<b>D</b>	<b>D</b>	<b>C</b>
2,5 m/s	<b>D</b>	<b>D</b>	<b>C</b>

## Sill profile

The **Duco Roof Turret Solid 30Z** also exists as a variant with sill profile. The sill profile ensures **better water drainage**. The sill profile allows the roof covering to be completely concealed. This provides an **aesthetic finish**. It also offers more placement options.



## OPTIONS DUCO ROOF TURRET SOLID 30Z

### DucoGrille Close 105

The DucoGrille Close 105 can, as an option, be integrated in the roof turret, thereby ensuring a controlled air supply or extraction. More info on the DucoGrille Close 105 can be found in our "Louvre Grilles" brochure.

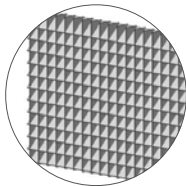
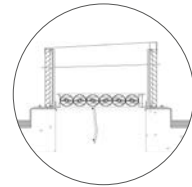

### Eggcrate grille

The Duco Roof Turret Solid 30Z is available with an optional Eggcrate grille, which provides even better water resistance (combination with the P2 louvre blades).

## ROOF COWLS WITH OTHER LOUVRE BLADES

In addition to the Duco Roof Turret Solid 30Z, DUCO also offers a system in which almost **all types of louvre blade** from the DucoWall range can be used. These roof cowls are made up of profiles from the DucoWall range. The upper panel and finishing thresholds are included. They are available as separate parts, semi-assembled kits or fully assembled kits. Do you need more info? Contact your DUCO dealer.

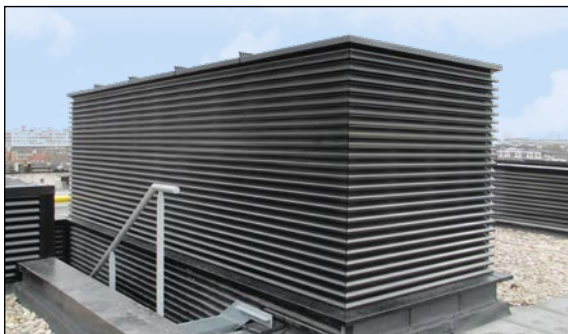
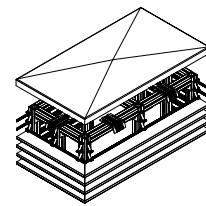

# IMPACT AND FALL-THROUGH PROTECTION

Façade elements are increasingly expected to meet 'impact protection' and 'fall-through protection' requirements:



## Impact protection

The resistance of a material to which an intense force or shock is exerted for a short period of time.



## Fall-through protection

The load applied to resist penetration that prevents people from falling through this barrier.

Note: often a specific mounting method applies or the test is only valid for specific versions (e.g. a certain step, a certain maximum span ...).

Contact DUCO for more information. Full test reports can be requested from DUCO.

### Overview of new results

DUCO products achieve very good results in terms of impact and fall-through protection:

	Impact protection		Fall-through protection			
	EN 13049	NF P08-302	B03-004	NEN EN1991-1-1	NF P01-013	BS6180
Maximum class	Class 5	H2	Class C5	Class C5	C1-C5/D	XI

#### DUCOWALL CLASSIC

DucoWall Classic W 130HP Metal Clip	Class 5	-	C5a	A/B/F/G	-	XI
-------------------------------------	---------	---	-----	---------	---	----





DucoWall **Screening 70**



DucoWall **Roof Turret**



DucoWall **Solid W 30Z**



DucoDoor **Wall**



DucoWall **Classic W 50/75Z**



DucoWall **Classic W 50Z**



DucoWall **Classic W 35V**





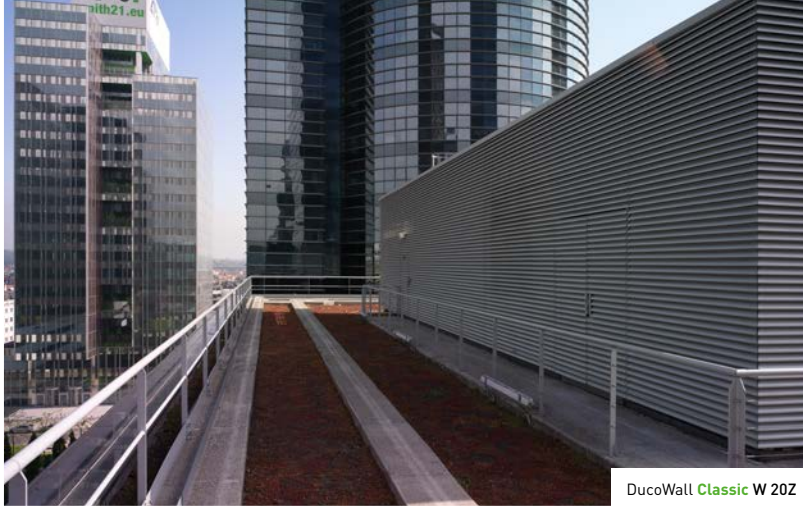

DucoWall Classic W 20Z

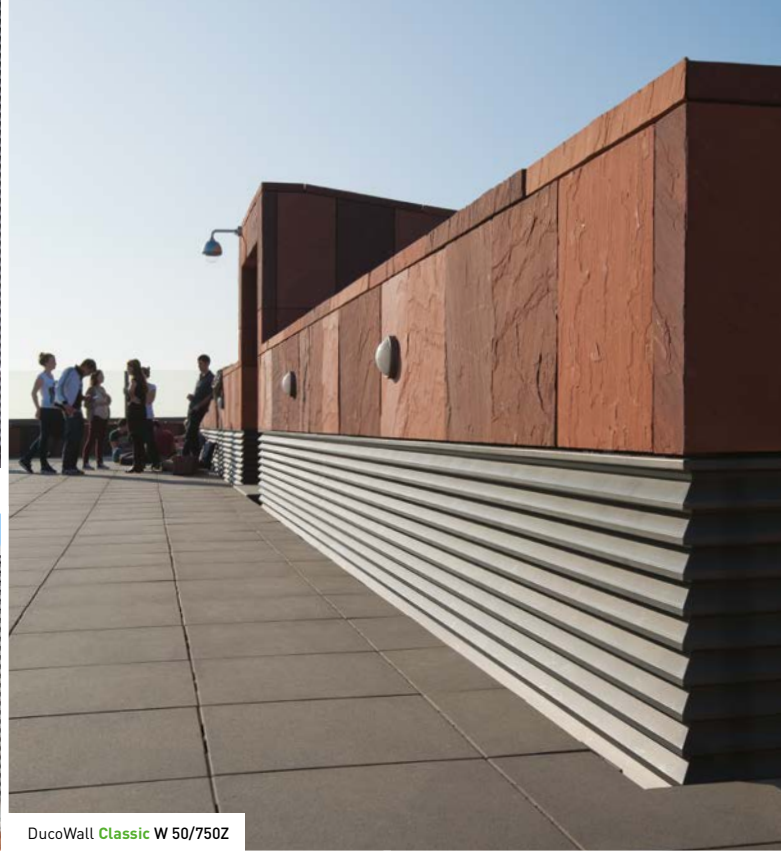

DucoWall Classic W 50/750Z



DucoWall Screening 70



DucoWall Classic W 35V  
DucoDoor Wall



DucoWall Classic W 50Z

DucoWall Solid W 30Z



Duco Roof Turret Solid 30Z





# SERVICE PLEASE!



To provide optimum support for your project, you will find professional **sectional drawings, technical data sheets, specification texts** and **assembly instructions** on our [website: www.duco.eu](http://www.duco.eu).

Find out what else DUCO can do for you.

## Calculating airflow → [airflowcalculation.duco.eu](http://airflowcalculation.duco.eu)

Calculate the required air flow rates, area or pressure differences for each type of louvre grille with this handy online tool.

Surface (m <sup>2</sup> )	Pressure drop (Pa)
<input type="text"/>	<input type="text"/>
<b>Air flow rate</b>	
Unit	<input type="text"/>
Pressure drop	<input type="text"/>
Surface	<input type="text"/>
<input type="button" value="Calculate"/>	

## BIM library → [www.duco.eu/bim](http://www.duco.eu/bim)

All products in this library are freely available in Autodesk Revit.

**Specification texts** → You will find specification texts for all products on our website [www.duco.eu](http://www.duco.eu).





## TAILORED **ADVICE**

DUCO offers tailored expertise & services for specifiers, and has a dedicated unit to advise and support architects, engineering offices and consultancies. DUCO works with reputable organisations such as the WTCB, the Von Karman Institute, etc. DUCO's knowledge and years of experience enable an appropriate solution to be offered for each of your projects.

**Any questions?** Please contact us at [info@duco.eu](mailto:info@duco.eu) or call +32 58 33 00 66 to for tailored advice!

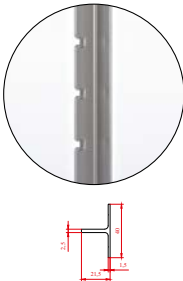
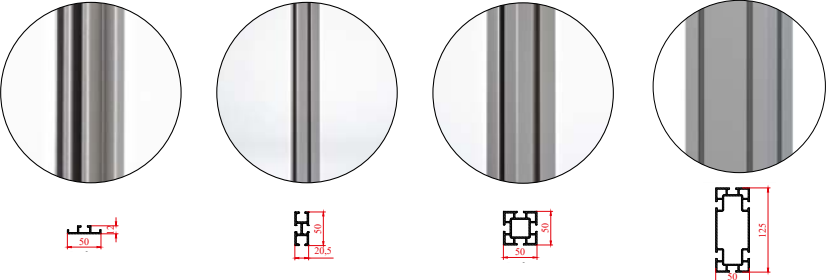
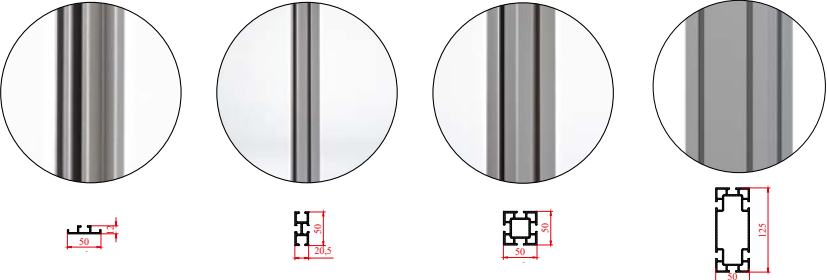
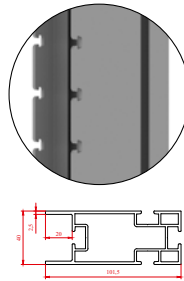
# OVERVIEW MULLIONS

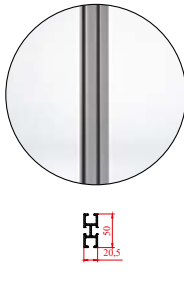
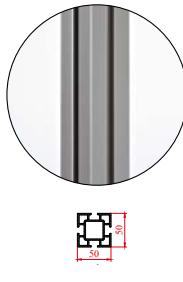
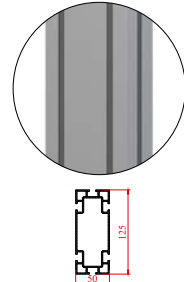
Louvre wall system	Available mullions
<p><b>DucoWall Solid</b></p>	<div style="display: flex; justify-content: space-around; text-align: center;"> <div> <p>40/21 mullion</p>  </div> <div> <p>40/21 Double mullion</p>  </div> <div> <p>40/70 Double mullion</p>  </div> <div> <p>Mullion 40/100 Double</p>  </div> </div>
<p><b>DucoWall Screening</b></p>	This row is merged with the one above in the original image, so no separate content is needed here
<p><b>DucoWall Classic</b></p>	<div style="display: flex; justify-content: space-around; text-align: center;"> <div> <p>50/12 mullion</p>  </div> <div> <p>21/50 MULTI mullion</p>  </div> <div> <p>50/50 mullion</p>  </div> <div> <p>50/125 mullion</p>  </div> </div>
<p><b>DucoWall Acoustic</b></p>	This row is merged with the one above in the original image, so no separate content is needed here



# TECHNICAL SPECIFICATION TABLE

		DUCOWALL SOLID															
		Solid 30Z see p. 8				Classic 20Z see p. 14		Classic 20V see p. 15		Classic 35V see p. 16		Classic 50Z/30° see p. 17					

## → Ventilation values

Feature	Unit	P1		P2		NP							65 pitch		75 pitch	
		STND	STND	+OPT	STND	STND	+OPT	STND	+OPT	STND	+OPT	STND	+OPT	STND	+OPT	
Visual free area	%	60	86	86	0	63	63	95	95	59	59	41	41	49	49	
Physical free area	%	34	48	48	0	47	47	37	37	35	35	40	40	46	46	
K factor, <b>intake</b> (lower is better)		21,43	18,26	18,58	n/a	22,68	24,27	41,62	45,04	71,82	74,32	14,57	15,62	10,27	10,41	
K factor, <b>exhaust</b> (lower is better)		17,08	13,62	14,13	n/a	30,52	33,03	41,62	45,04	65,04	66,10	10,54	10,96	8,70	8,86	
Ce (higher is better)		0,216	0,234	0,232	n/a	0,210	0,203	0,155	0,149	0,118	0,116	0,262	0,253	0,312	0,310	
Cd (higher is better)		0,242	0,271	0,266	n/a	0,181	0,174	0,155	0,149	0,124	0,123	0,308	0,302	0,339	0,336	

## → Water resistance

Feature	Unit	P1		P2		NP							65 pitch		75 pitch	
		STND	STND	+OPT	STND	STND	+OPT	STND	+OPT	STND	+OPT	STND	+OPT	STND	+OPT	
Water resistance for v = 0 m/s	class	B	B	B	n/a	C	B	A	A	A	A	B	A	B	B	
Water resistance for v = 0.5 m/s	class	B	C	B	n/a	C	B	B	A	A	A	C	B	C	B	
Water resistance for v = 1.0 m/s	class	C	C	B	n/a	D	C	C	B	A	A	C	B	C	C	
Water resistance for v = 1.5 m/s	class	C	C	B	n/a	D	D	D	B	A	A	C	C	C	C	
Water resistance for v = 2.0 m/s	class	D	D	C	n/a	D	D	D	C	C	B	D	C	D	C	
Water resistance for v = 2.5 m/s	class	D	D	D	n/a	D	D	D	D	C	C	D	C	D	D	

## → Sound reduction

Solution		Unit	P1	P2	NP							65 pitch		75 pitch	
Rw		dB	n/a	n/a	n/a	n/a	n/a	n/a	n/a	n/a	n/a	n/a	n/a	n/a	n/a
C			n/a	n/a	n/a	n/a	n/a	n/a	n/a	n/a	n/a	n/a	n/a	n/a	n/a
C <sub>r</sub>			n/a	n/a	n/a	n/a	n/a	n/a	n/a	n/a	n/a	n/a	n/a	n/a	n/a
Octave band values	at 125 Hz	dB	n/a	n/a	n/a	n/a	n/a	n/a	n/a	n/a	n/a	n/a	n/a	n/a	n/a
	at 250 Hz	dB	n/a	n/a	n/a	n/a	n/a	n/a	n/a	n/a	n/a	n/a	n/a	n/a	n/a
	at 500 Hz	dB	n/a	n/a	n/a	n/a	n/a	n/a	n/a	n/a	n/a	n/a	n/a	n/a	n/a
	at 1000 Hz	dB	n/a	n/a	n/a	n/a	n/a	n/a	n/a	n/a	n/a	n/a	n/a	n/a	n/a
	at 2000 Hz	dB	n/a	n/a	n/a	n/a	n/a	n/a	n/a	n/a	n/a	n/a	n/a	n/a	n/a
	at 4000 Hz	dB	n/a	n/a	n/a	n/a	n/a	n/a	n/a	n/a	n/a	n/a	n/a	n/a	n/a

## → Mullions and dimensions

Feature		Unit	P1	P2	NP							65 pitch		75 pitch	
Spacing of the louvre (pitch)		mm		37,5		35	20	35	35	65	75				
Louvre depth		mm		30		23	23	38	53	53					
Recess depth at mullion ...	Solid Screening	40/21 (Double)	mm	51		×	×	×	×	×	×				
		40/70 Double	mm	102		×	×	×	×	×	×				
		40/100 Double	mm	132		×	×	×	×	×	×				
	Classic Acoustic	50/12	mm		×		35	35	50	65	65				
		21/50 MULTI	mm		×		73	73	88	103	103				
		50/50	mm		×		73	73	88	103	103				
		50/125	mm		×		148	148	163	178	178				
Maximum span between 2 mullions		mm		1970		1200	1850	2650	2050	2050					

STND and +OPT version: see page 5



# TECHNICAL SPECIFICATION TABLE

## DUCOWALL ACOUSTIC

**Acoustic 75Z**  
see p. 28

**Acoustic 75L**  
see p. 28

**Acoustic 150**  
see p. 29

**Acoustic 300**  
see p. 29

### → Ventilation values

Feature	Unit	Acoustic 75Z		Acoustic 75L		Acoustic 150		Acoustic 300	
		STND	+OPT	STND	+OPT	STND	+OPT	STND	+OPT
Visual free area	%	76	76	95	95	74	74	74	74
Physical free area	%	28	28	28	28	35	35	35	35
K factor, <b>intake</b> (lower is better)		26,03	26,03	22,25	22,89	11,04	11,49	13,52	16,00
K factor, <b>exhaust</b> (lower is better)		29,86	30,19	15,02	15,50	10,96	11,41	13,52	16,00
Ce (higher is better)		0,196	0,196	0,212	0,209	0,301	0,295	0,272	0,250
Cd (higher is better)		0,183	0,182	0,258	0,254	0,302	0,296	0,272	0,250

### → Water resistance

Feature	Unit	Acoustic 75Z		Acoustic 75L		Acoustic 150		Acoustic 300	
		STND	+OPT	STND	+OPT	STND	+OPT	STND	+OPT
Water resistance for v = 0 m/s	class	B	B	B	B	B	B	A	A
Water resistance for v = 0.5 m/s	class	B	B	B	B	C	C	B	B
Water resistance for v = 1.0 m/s	class	C	C	C	C	C	C	B	B
Water resistance for v = 1.5 m/s	class	C	C	D	D	C	C	C	C
Water resistance for v = 2.0 m/s	class	D	D	D	D	D	D	C	C
Water resistance for v = 2.5 m/s	class	D	D	D	D	D	D	D	D

### → Sound reduction

Solution			Acoustic 75Z	Acoustic 75L	Acoustic 150	Acoustic 300
Rw		dB	6	6	11	17
C			0	0	-1	-1
C <sub>tr</sub>			-1	-2	-2	-3
Octave band values	at 125 Hz	dB	2,7	2,6	4,8	7,8
	at 250 Hz	dB	3,5	3	4	8
	at 500 Hz	dB	2,1	1,9	7,4	14,9
	at 1000 Hz	dB	4,8	4,4	11,4	17,8
	at 2000 Hz	dB	10,1	9,7	12,4	17,7
	at 4000 Hz	dB	12,4	11,5	13	22,4

### → Mullions and dimensions

Feature		Unit	Acoustic 75Z	Acoustic 75L	Acoustic 150	Acoustic 300	
Spacing of the louvre (pitch)		mm	60	60	150	150	
Louvre depth		mm	67	75	142	142	
Recess depth at mullion ...	Solid Screening	40/21 (Double)	mm	×	×	×	
		40/70 Double	mm	×	×	×	
		40/100 Double	mm	×	×	×	
	Classic Acoustic	50/12	mm	79	87	154	×
		21/50 MULTI	mm	117	125	192	334
		50/50	mm	117	125	192	334
50/125	mm	192	200	267	×		
Maximum span between 2 mullions		mm	1700	1650	2150	2150	

STND and +OPT version: see page 5

## DUCOWALL SCREENING

### Screening 35

see p. 12

### Screening 70

see p. 13

75 pitch		112 pitch		150 pitch		75 pitch		112 pitch		150 pitch	
STND	+OPT	STND	+OPT	STND	+OPT	STND	+OPT	STND	+OPT	STND	+OPT
52	52	68	68	76	76	53	53	68	68	77	77
29	29	27	27	35	35	37	37	59	59	55	55
61,04	61,04	67,19	68,30	23,56	24,03	30,19	30,52	22,25	22,25	13,72	14,35
38,10	38,58	33,03	32,65	19,93	20,29	25,00	25,77	13,72	14,13	10,21	10,54
0,128	0,128	0,122	0,121	0,206	0,204	0,182	0,181	0,212	0,212	0,270	0,264
0,162	0,161	0,174	0,175	0,224	0,222	0,200	0,197	0,270	0,266	0,313	0,308

75 pitch		112 pitch		150 pitch		75 pitch		112 pitch		150 pitch	
STND	+OPT	STND	+OPT	STND	+OPT	STND	+OPT	STND	+OPT	STND	+OPT
A	A	B	B	C	C	B	A	B	B	C	C
B	B	C	B	C	C	C	B	C	B	D	C
B	B	C	C	D	D	C	C	C	C	D	D
D	D	D	D	D	D	C	C	C	C	D	D
D	D	D	D	D	D	D	D	D	C	D	D
D	D	D	D	D	D	D	D	D	D	D	D

75 pitch	112 pitch	150 pitch	75 pitch	112 pitch	150 pitch
n/a	n/a	n/a	n/a	n/a	n/a
n/a	n/a	n/a	n/a	n/a	n/a
n/a	n/a	n/a	n/a	n/a	n/a
n/a	n/a	n/a	n/a	n/a	n/a
n/a	n/a	n/a	n/a	n/a	n/a
n/a	n/a	n/a	n/a	n/a	n/a
n/a	n/a	n/a	n/a	n/a	n/a
n/a	n/a	n/a	n/a	n/a	n/a
n/a	n/a	n/a	n/a	n/a	n/a

75 pitch	112 pitch	150 pitch	75 pitch	112 pitch	150 pitch
75	112	150	75	112	150
43	43	43	82	82	82
57	57	57	94,5	94,5	94,5
107	107	107	145	145	145
137	137	137	175	175	175
	×			×	
	×			×	
	×			×	
	×			×	
	1650		2400	2400	2400





A **SOLUTION**  
FOR EVERY  
PROJECT

**DUCO**