

LOUVRE GRILLES

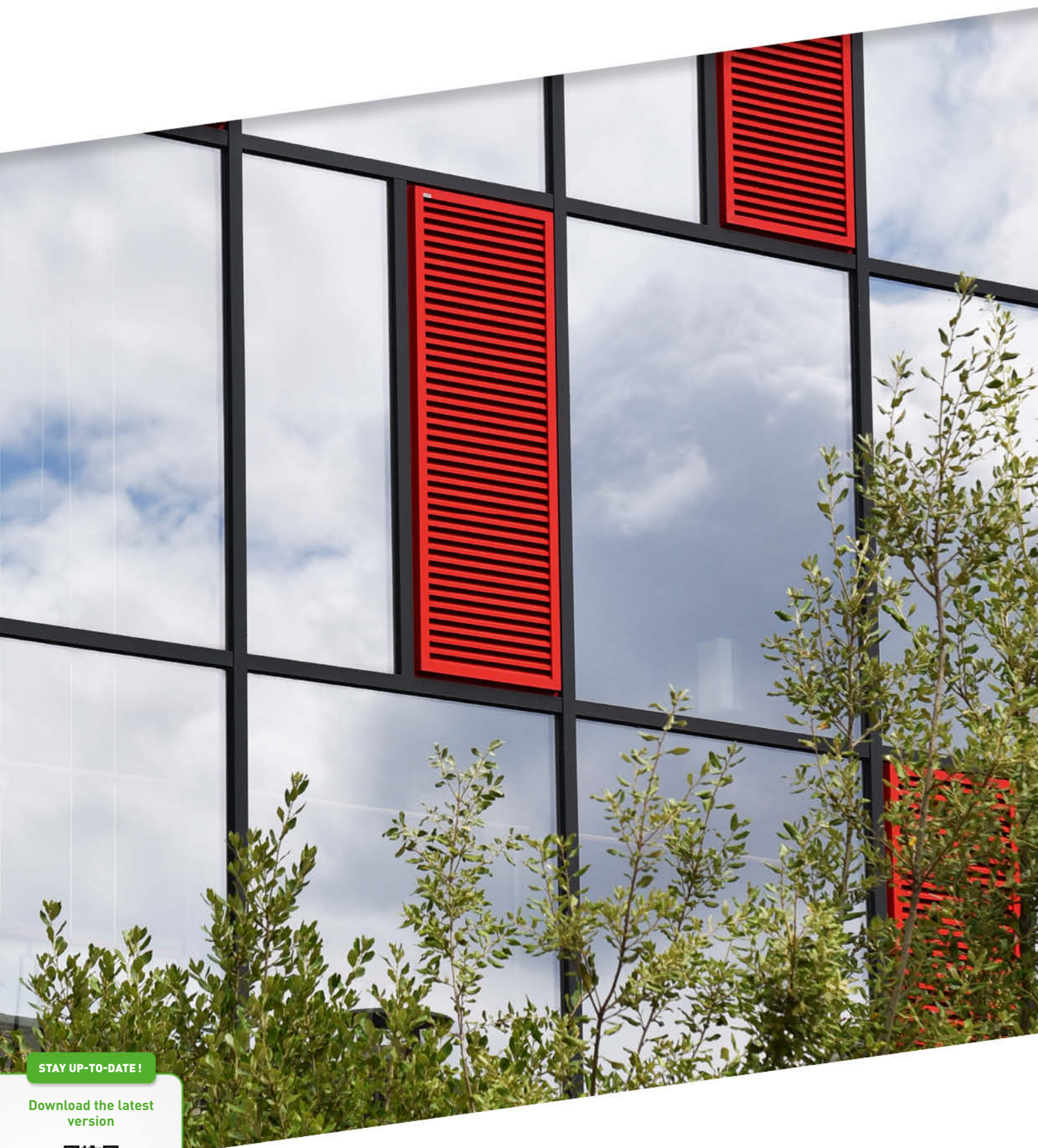

STAY UP-TO-DATE!

Download the latest
version



link.duco.eu/brochure

DUCO

HOME OF OXYGEN

DUCO Ventilation & Sun Control provides every building with a healthy supply of oxygen. With a comprehensive range of innovative natural and mechanical ventilation systems, either combined with external solar shading or otherwise, DUCO offers the ultimate guarantee of a healthy and comfortable indoor climate. The occupant's health is,

therefore, central to DUCO. A well-thought-out combination of basic ventilation, mechanical extraction, purge ventilation and solar shading ensures optimum air quality. DUCO provides an innovative solution for residential buildings, offices, schools or care centres where everyone feels at home.

DUCO, Home of Oxygen

DUCO

GENERAL	4
PRODUCTS	6
DUCOGRILLE SOLID	
DucoGrille Solid 30Z	8
DucoGrille Solid MR 30Z	9
DucoGrille Solid++ 30Z	10
DucoGrille Solid ISO 30Z	11
DucoGrille Solid G 30Z Barrier Load	12
DUCO BARRIER LOAD LOUVRE	
Duco Barrier Load Louvre	13
DUCOGRILLE CLASSIC	
DucoGrille Classic 20Z	14
DucoGrille Classic 20V	15
DucoGrille Classic 50Z	16
DucoGrille Classic 50/75Z	17
DucoGrille Classic 45HP	18
DucoGrille Classic 50HP	19
DucoGrille Classic 60HP	20
DucoGrille Classic 60HP Vertical	21
DucoGrille Classic 130HP	22
DucoGrille Classic 130HP Basic	23
DucoGrille Classic 70V	24
DucoGrille Classic 70V Vertical	25
DUCOGRILLE ACOUSTIC	
DucoGrille Acoustic 75Z & 75L	28
DucoGrille Acoustic 150	29
Duco Acoustic Panel	30
DUCOGRILLE TRANSFER	
DucoGrille Transfer	32
DucoGrille Transfer Acoustic	33
DUCOGRILLE CLOSE	
DucoGrille Close 105	34
DucoGrille Close 35Z	36
DucoGrille Close M 100	37
DUCOGRILLE NIGHTVENT	
DucoGrille NightVent	38
ROOF TURRETS	
Duco Roof Turret Solid 30Z	42
VENTILATIVE COOLING	44
IMPACT AND FALL-THROUGH PROTECTION	46
REFERENCE PROJECTS	48
VARIOUS	50
Service	50
Dimensions and ordering information	51
Technical specification table	52

DISCLAIMER

Illustrations in this catalogue may differ from actual product. Printing errors and/or changes excepted. DUCO reserves the right to amend this information at any time. The information stated is valid as at 13.11.2024 and may be subject to changes in legislation.

A SOLUTION FOR EVERY SITUATION



→ Any building situation

DUCO has a wide range of natural air intake grilles for **both new buildings and refurbishment projects**. Depending on the type of grille, Duco offers the following options:

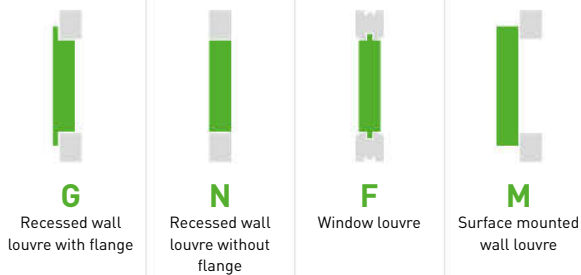

→ Finish

Each type of grille is available in any colour: **F1***, every RAL colour, textured paint, special paints/lacquers, etc. Every type of grille is lacquered as standard in **SeaSide** grade. In addition, every type of grille in this brochure complies with the **Qualicoat** or **Qualanod** quality specifications.

* Except DucoGrille Transfer Acoustic



→ Vandalism and intrusion security

Solid louvre blades are very sturdy and **'vandal-proof'**. The DucoGrille Solid++ is **burglar resistant up to class 2**, in accordance with the European standard.



→ Penetration security

DucoGrille Classic louvre grilles with **V-blades** are penetration-proof.



→ Sound absorption

DucoGrille **Acoustic** louvre blades are fitted on the inside with non-combustible mineral wool and are ideally suited for applications with high levels of noise intrusion.



→ Insect screen and vermin screen

With DucoGrille Solid louvre grilles with small punching (P1), the **perforated louvre blades** act as an insect screen. With all other types* (Solid P2, Classic, Acoustic and Close 35Z), **2.3 x 2.3 mm stainless-steel mesh** is provided as standard. 6 x 6 mm or 20 x 20 mm mesh can be selected as an option.



P1



P2



Stainless-steel mesh

* Duco Acoustic Panel, DucoGrille Close 105 and DucoGrille Transfer do not have standard insect screening.

→ Ventilation capacity

Each louvre is extensively tested and optimised by DUCO's R&D department. Many 'High Performance' HP louvre blades in the DucoGrille Classic range ensure excellent airflow thanks to low resistance.

Air flow performance class	Ce or Cd
1	≥ 0,4
2	0,3 - 0,399
3	0,2 - 0,299
4	≤ 0,199

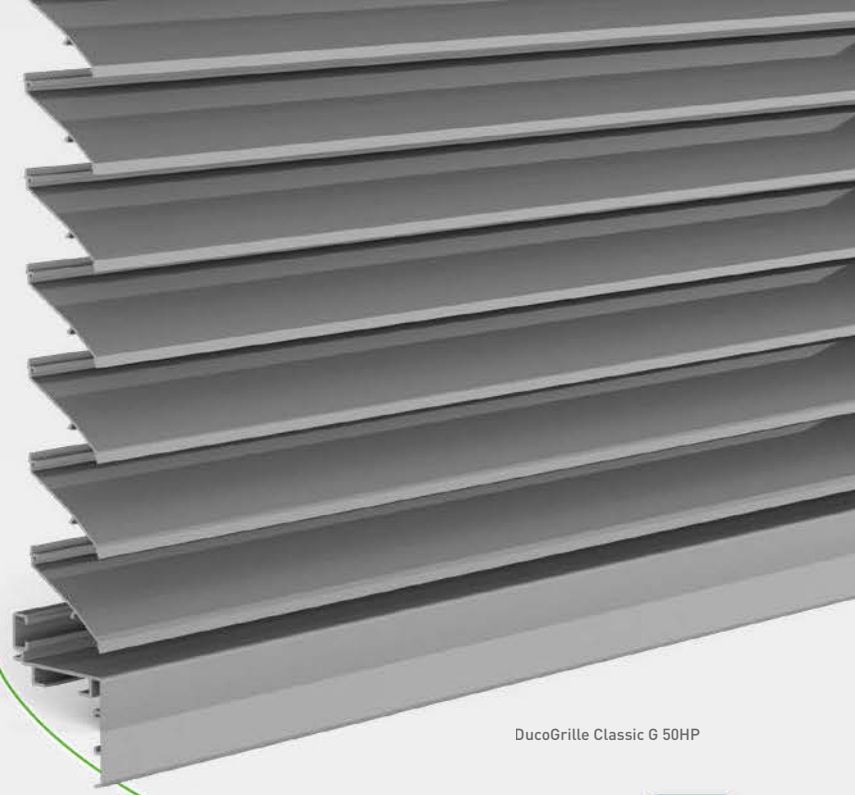

DucoGrille Classic G 50HP

→ Water resistance

All DucoGrille louvre grilles have been tested by **BSRIA** in accordance with watertightness tests developed in collaboration with HEVAC. The test simulates 75 litres per hour rainfall at a wind speed of 13 metres per second. Based on the air speed in the louvre and the % of watertightness, the louvre is assigned a class.

EN13030

Class A	100 - 99 %
Class B	98,5 - 95 %
Class C	94,9 - 80 %
Class D	< 80 %

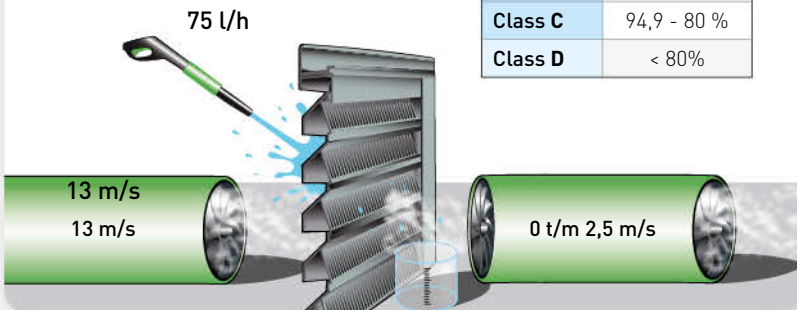

→ High Performance

HP

HP louvre grilles offer **high performance in terms of air passage or water resistance**, or in many cases a combination of both properties.

→ Custom building

The height and width of each grille* can be determined to the mm.

* With the exception of DucoGrille Acoustic 150, DucoGrille Close 35Z and DucoGrille Transfer.

→ STND and +OPT version

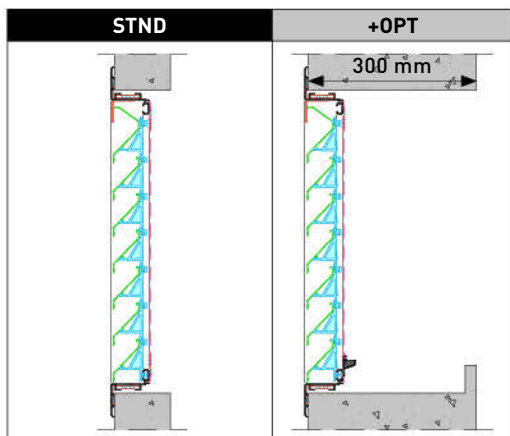

The technical values of our grilles have been tested in two ways:

STND = 'Standard'

This is the standard version.

+OPT = '+Options'

This is an optional version where the grille was tested in an installation situation of 300 mm and with (integrated) water gutter*.

The +OPT version will often bring better results in terms of water resistance. See each product page for all values per grille type.

* Depending on the type of grille

PRODUCT OVERVIEW

Ventilation capacity

— = at intake
— = at exhaust

The longer the bar, the more important the air flow.

STND and +OPT version: see page 5

G

Recessed wall louvre with flange

N

Recessed wall louvre without flange

F

































Window louvre

M

Surface mounted wall louvre

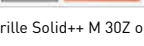
DUCOGRILLE SOLID

Sturdy, **vandal-proof / burglary resistant** louvre grilles with multiple, sleek dovetailing Z-blades.

Product	Icons	STND	+OPT	G	N	F	M	Page
DucoGrille Solid 30Z	 							see p. 8
DucoGrille Solid++ 30Z	   							see p. 10
DucoGrille Solid ISO 30Z	 		 n/a					see p. 11
DucoGrille Solid 30Z Barrier Load	 							see p. 12

* DucoGrille Solid++ G 30Z complies with impact and fall-through protection, DucoGrille Solid++ M 30Z only complies with fall-through protection.













































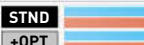











































BARRIER LOAD LOUVRE

Fall through protection grilles for open windows at great heights.

Product	STND	+OPT	G	N	F	M	Page
Duco Barrier Load Louvre	n/a	n/a					see p. 13

DUCOGRILLE CLASSIC

Recessed wall or window louvres, where the aluminium louvre blades are clicked into place on **blade holders**.

Product	Icons	STND	+OPT	G	N	F	M	Page
DucoGrille Classic 20Z								see p. 14
DucoGrille Classic 20V	 							see p. 15
DucoGrille Classic 50Z								see p. 16
DucoGrille Classic 50/75Z								see p. 17
DucoGrille Classic 45HP								see p. 18
DucoGrille Classic 50HP								see p. 19
DucoGrille Classic 60HP	 							see p. 20
DucoGrille Classic 60HP Vertical	 		 n/a					see p. 21
DucoGrille Classic 130HP	 		 n/a					see p. 22
DucoGrille Classic 130HP Basic	 		 n/a					see p. 23
DucoGrille Classic 70V	 							see p. 24
DucoGrille Classic 70V Vertical	 							see p. 25

Legend



Vandal-proof
The grille is vandal-proof



Penetration safe
The grille is penetration-proof





Impact protection
Resistant to intense shocks



Fall-through protection
Prevents people from falling through

Ventilation capacity

 = at intake
 = at exhaust
 The longer the bar, the more important the air flow.

STND and +OPT version: see page 5



G
Recessed wall louvre with flange



N
Recessed wall louvre without flange





















F
Window louvre



M
Surface mounted wall louvre





DUCOGRILLE ACOUSTIC

Recessed wall louvres featuring **sound-absorbing**, non-combustible mineral wool.

DucoGrille Acoustic 75Z		 	<input checked="" type="checkbox"/>	<input type="checkbox"/>	<input type="checkbox"/>	<input type="checkbox"/>	see p. 28
DucoGrille Acoustic 75L		 	<input checked="" type="checkbox"/>	<input type="checkbox"/>	<input type="checkbox"/>	<input type="checkbox"/>	see p. 28
DucoGrille Acoustic 150	 +	  n/a	<input checked="" type="checkbox"/>	<input checked="" type="checkbox"/>	<input type="checkbox"/>	<input type="checkbox"/>	see p. 29
Duco Acoustic Panel 150	   +	 	<input checked="" type="checkbox"/>	<input checked="" type="checkbox"/>	<input type="checkbox"/>	<input type="checkbox"/>	see p. 30
Duco Acoustic Panel 300	   +	 	<input checked="" type="checkbox"/>	<input checked="" type="checkbox"/>	<input type="checkbox"/>	<input type="checkbox"/>	see p. 30





DUCOGRILLE TRANSFER

Transfer grille for doors and walls.

DucoGrille Transfer		  n/a					Installation in door or wall with/without counterframe	see p. 32
DucoGrille Transfer Acoustic							Installation in door or wall with/without counterframe	see p. 33

DUCOGRILLE CLOSE

Adjustable louvre grilles with manual or electric operation.

DucoGrille Close 105		Ventilation capacity depending on internal and external louvre grille	<input type="checkbox"/>	<input type="checkbox"/>	<input type="checkbox"/>	<input type="checkbox"/>	see p. 34
DucoGrille Close 35Z		  n/a	<input checked="" type="checkbox"/>	<input checked="" type="checkbox"/>	<input checked="" type="checkbox"/>	<input type="checkbox"/>	see p. 36
DucoGrille Close M 100		  n/a	<input type="checkbox"/>	<input type="checkbox"/>	<input type="checkbox"/>	<input checked="" type="checkbox"/>	see p. 37

DUCOGRILLE NIGHTVENT

Glass-replacing ventilation hatch with manual or electronic operation.

DucoGrille NightVent	 	  n/a	<input type="checkbox"/>	<input type="checkbox"/>	<input checked="" type="checkbox"/>	<input type="checkbox"/>	see p. 38
-----------------------------	---	--	--------------------------	--------------------------	-------------------------------------	--------------------------	-----------

ROOF TURRETS

Kits and components to build roof turrets with DucoWall louvre blades.

Duco Roof Turret Solid 30Z		  n/a	<input type="checkbox"/>	<input type="checkbox"/>	<input type="checkbox"/>	<input type="checkbox"/>	see p. 42
-----------------------------------	--	--	--------------------------	--------------------------	--------------------------	--------------------------	-----------

Legend



Burglar resistant
The grille is (optionally) burglar resistant up to class 2



Water resistant
The louvre grille is water resistant to a high or very high degree



Sound absorption
Can be used in projects with light or heavy (+) noise exposure



High Performance
The louvres are optimised for high performance



Fall-through protection



Vandal-proof

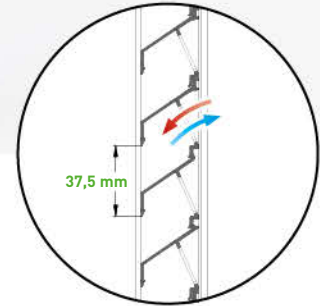

DucoGrille Solid 30Z

DucoGrille Solid 30Z louvre blades offer high ventilation capacity with relatively small louvre blades. The 'stackable' louvre blades form a single screen, making them **extra strong** and **vandal-proof**.

The louvre blades are available with **small punching (P1)**, **large punching (P2)** or as **false louvres (NP)** and provide a uniform façade design when combined in a single project.

DucoGrille Solid 30Z grilles comply with the BS6180 standard (class X or XI) for **fall-through protection** (except MR30Z and Solid ISO). See page 46-47 for more information.

FRAME TYPES AND DIMENSIONS

Dimensions in mm	G	G Large	F 30Z/24	F 30Z/28 30Z/32	M
Louvre pitch	37,5				
Installation depth	34,4	31,9	-	-	-
Frame rebate	18,2	40	-	-	-
Frame depth	-	-	38	42	43
Flange width	-	-	24	28/32	-
Min. dimensions	min. W 200 x H 200				

VENTILATION VALUES

Feature		P1		P2	
		STND	+OPT	STND	+OPT
Visual free area		60 %	60 %	86 %	86 %
Physical free area		34 %	34 %	48 %	48 %
Ce (higher is better)		0,243	0,216	0,258	0,232
Cd (higher is better)		0,234	0,242	0,253	0,266
K-FACTOR (lower is better)	INTAKE	16,94	21,43	15,02	18,58
	EXHAUST	18,26	17,08	15,62	14,13

STND and +OPT version: see page 5

WATER RESISTANCE

Air velocity	Class			
	P1		P2	
	STND	+OPT	STND	+OPT
0 m/s	B	B	C	B
0,5 m/s	C	B	C	B
1 m/s	C	C	C	B
1,5 m/s	D	C	D	B
2 m/s	D	D	D	C
2,5 m/s	D	D	D	D

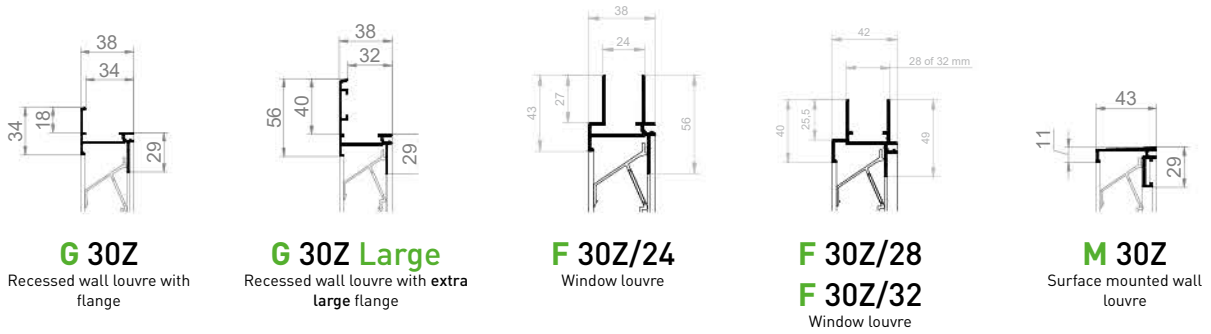

Punching

DucoGrille Solid 30Z is available with louvre blades with **small punching (P1)**, **large punching (P2)** or without punching as **false louvres (NP)**. Combining the two in the same project ensures a uniform appearance.

INSECT SCREEN

Punching				
		P1	P2	NP
Resistant to...		Perforated louvre blades as insect screen	Stainless-steel mesh 2.3 x 2.3 mm STANDARD	100 % false louvre
			Stainless-steel mesh 6 x 6 mm OPTIONAL	
			Stainless-steel mesh 20 x 20 mm OPTIONAL	

Round version: MR 30Z

The **DucoGrille Solid MR 30Z** is a round surface mounted wall louvre.

DIMENSIONS

	MR 30Z
Frame depth	35 mm
Min. / max. dimensions	min. dia. 300 mm max. Ø 1500 mm

Stainless-steel mesh is not available for round louvre grilles. All other dimensions and properties are the same as for the DucoGrille Solid M 30Z.

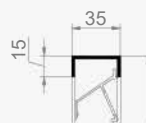

MR 30Z
Surface mounted wall louvre





Fall-through protection



Burglar resistant up to class 2

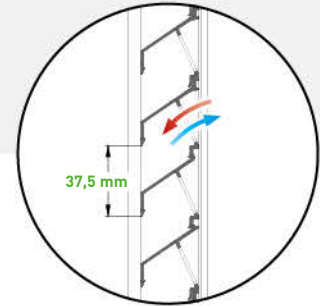

DucoGrille Solid++ 30Z

The DucoGrille Solid++ 30Z uses the same louvre blades as the Solid 30Z (P1 only), but with a **reinforced frame section**. This makes the louvre grilles **burglar resistant up to Class 2**, in accordance with the European standard.

DucoGrille Solid++ G 30Z grilles comply with class 5 of EN13049 for **impact protection**. DucoGrille Solid++ 30Z grilles meet the BS6180 standard (class X or XI) for **fall-through protection**. See page 46-47 for all classes per country.

FRAME TYPES AND DIMENSIONS

Dimensions in mm	G	M
Louvre pitch	37,5	
Installation depth	38,4	-
Frame rebate	15	-
Frame depth	-	42
Min. dimensions	min. W 200 x H 200	

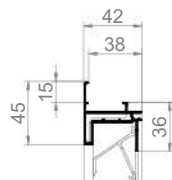

++ G 30Z

Recessed wall louvre with flange

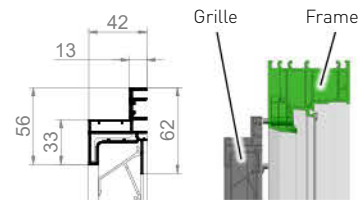

++ M 30Z

Surface mounted louvre grille for fitting on a frame

SPECIFICATIONS

The DucoGrille Solid++ 30Z is only available with P1 louvre blades. All specifications relating to ventilation capacity, water resistance and insect resistance are identical to the DucoGrille Solid 30Z P1 (see page 8).



P1

DucoGrille **Solid++ G 30Z** has passed all the tests prescribed in the 'Burglar resistance Construction products' prEN 1627 to prEN 1630 draft standards for class 2 intrusion resistance.

DucoGrille **Solid++ M 30Z** complies with standards NEN 5096:2007 and EN 1627:2011

The complete test report is obtainable upon request:
G 30Z: DE 651 XG 815 - CAR 8175 | **M 30Z:** SKG12.1036





Also available in **RC2 intrusion-resistant** version

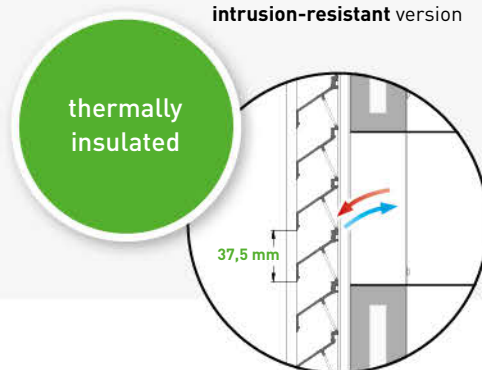

DucoGrille Solid ISO 30Z

The DucoGrille Solid ISO 30Z is an architectural and **thermally insulated window louvre**. The window louvre can be connected to both round and rectangular air ducts. Available as an option with reinforced frame section for burglary-resistance up to class 2 (only with P1 blades).

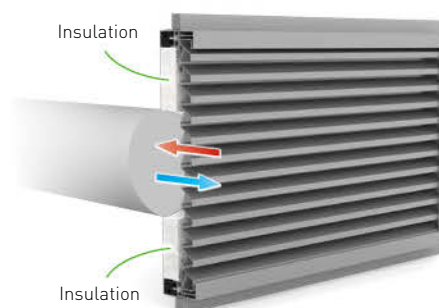

DIMENSIONS AND SPECIFICATIONS

Frame depth	88 mm (with thermal break)
Flange width	24 / 28 / 32 / 36 / 40 / 44 / 48 mm
Duct connection	Round or rectangular, any dimension
Grille dimensions	Louvre grille height = duct height + 2 x 63 mm min. Grille width = duct width + 2 x 63 mm min. Min. W 300 x H 300 mm Max. 2900 mm high / wide if other dimension < 1250 mm
U-value	0.9 W/m ² K

→ Rear for **round** duct

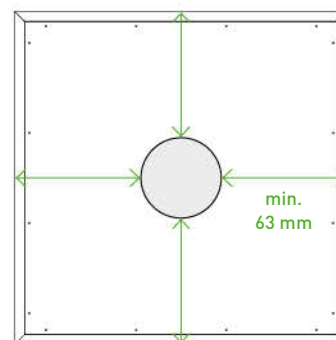

→ Rear for **rectangular** duct

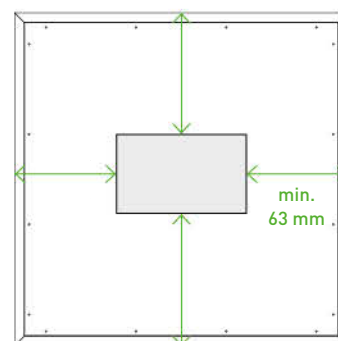

SPECIFICATIONS

The DucoGrille Solid ISO 30Z is available with P1 and P2 louvre blades. All specifications relating to ventilation capacity and water resistance are identical to the corresponding DucoGrille Solid 30Z models (see page 8).

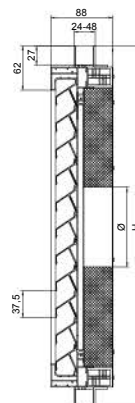



Fall-through protection



Impact protection

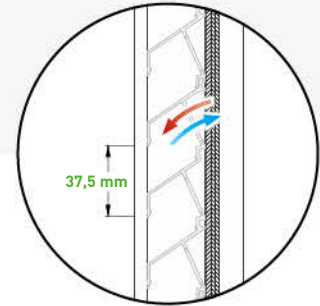

DucoGrille

Solid G 30Z Barrier Load

The DucoGrille Solid 30Z Barrier Load is ideally suited for high-rise applications such as student housing, retail and commercial buildings.

It meets the highest standards in **fall-through protection** and **impact protection** (see page 46-47 for more info).

Fall-through protection standards:

- B03-004: Class C4
- NEN EN1991-1-1: A/B/F/G
- NF P01-013: A/B (Width < 600 mm)
- BS6180: XI

Impact protection standards:

- EN13049: Class 5
- NF P08-302: H2/C2

Furthermore, the DucoGrille Solid 30Z Barrier Load offers the same benefits for purge ventilation as the DucoGrille Solid G 30Z (see page 8).

FRAME TYPES AND DIMENSIONS

Dimensions in mm	G
Louvre pitch	37,5
Installation depth	-
Frame rebate	15
Frame depth	42
Min. dimensions	min. W 200 x H 200

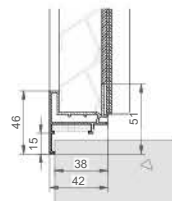

G 30Z
Barrier Load

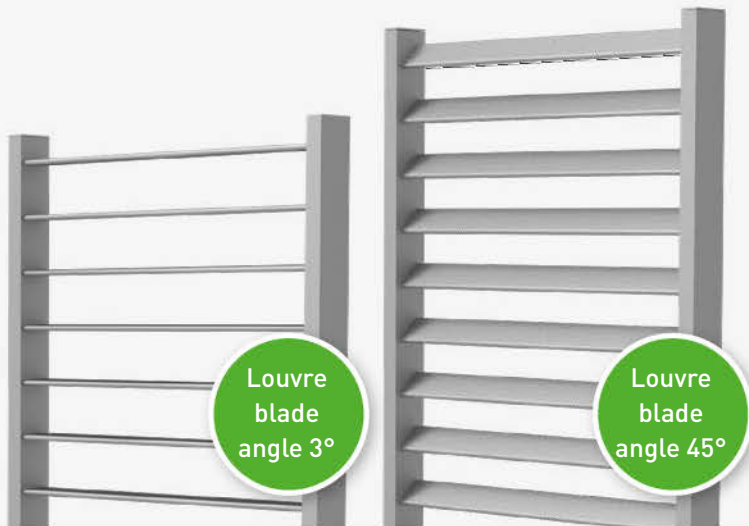

Fall-through protection



Impact protection

Duco Barrier Load Louvre

Barrier Load Louvres have several advantages, such as fall through protection for open windows at great heights and intensive ventilation of the rooms inside the building. At the same time, the louvre blades provide solar shading while blocking out the sun's rays and heat without loss of daylight. In addition to these functions, DUCO Barrier Load Louvres also provide an architectural aspect to the façade. This type of louvres is widely used in student housing, but can be adapted to any project.

It meets the highest standards in **fall-through protection** and **impact protection** (see page 46-47 for more info).

Fall-through protection standards:

- B03-004: Class A/B/C4/D
- EN1991-1-1: Class A/B/C4/D
- BS6180: XI

Impact protection standards:

- EN13049: Class 5
- NF P08-302:
 - Louvre blade angle 3°: Class Q4
 - Louvre blade angle 45° and 55°: Class H2

FRAME TYPES AND DIMENSIONS

Dimensions in mm	SlimFrame 11/70	LuxFrame 35/70
Louvre pitch	min. 50, max. 100	min. 50, max. 100
Installation depth	70	70
Frame depth	11	35
Min. dimensions	min. W 100	min. W 100
Max. dimensions	max. W 1000	max. W 1000

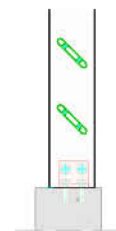

Mounted on the four corners

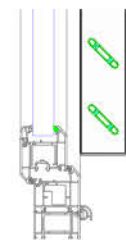

Mounted directly on the window frame

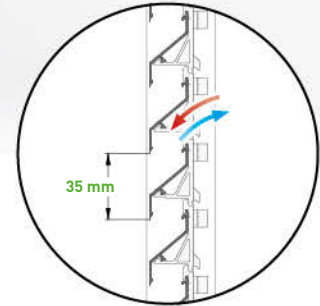

DucoGrille Classic 20Z

DucoGrille Classic 20Z consists of two different types: a recessed wall louvre (G) and an architectural window louvre (F). All types are manufactured from extruded aluminium sections. Insect mesh is fitted as standard. The “Z”-shaped louvre blade produces a sleek design.

FRAME TYPES AND DIMENSIONS

Dimensions in mm	G	F
Louvre pitch	35	
Installation depth	30	-
Frame rebate	19	-
Flange width	-	24
Frame depth	-	35
Min. dimensions	min. W 200 x H 200	

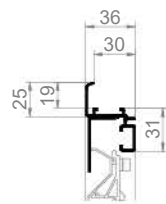

G 20Z
Recessed wall louvre
with flange

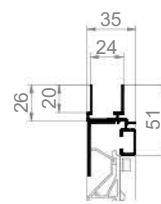

F 20Z
Window louvre

VENTILATION VALUES

Feature		STND	+OPT
Visual free area		63 %	63 %
Physical free area		41 %	41 %
Ce (higher is better)		0,203	0,203
Cd (higher is better)		0,174	0,174
K-FACTOR (lower is better)	INTAKE	24,27	24,27
	EXHAUST	33,03	33,03

WATER RESISTANCE

Air velocity	Class	
	STND	+OPT
0 m/s	C	B
0,5 m/s	C	B
1 m/s	C	C
1,5 m/s	D	D
2 m/s	D	D
2,5 m/s	D	D

STND and +OPT version: see page 5 Insect protection: standard stainless steel mesh 2.3 x 2.3 mm, optional stainless steel mesh 6 x 6 mm or stainless steel mesh 20 x 20 mm



→ Dimensions & order information: see page 51
→ Full specifications: see page 52



Good water resistance

Penetration safe

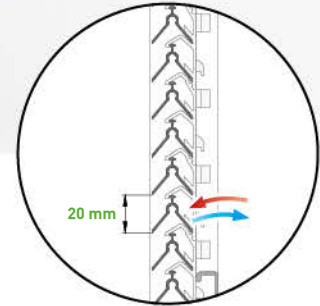

DucoGrille Classic 20V

DucoGrille Classic 20V consists of two different types: a recessed wall louvre (G) and an architectural window louvre (F). All types are manufactured from extruded aluminium sections. Insect mesh is fitted as standard. The “V”-shaped louvre blade produces a sleek design.

FRAME TYPES AND DIMENSIONS

Dimensions in mm	G	F
Louvre pitch	20	
Installation depth	30	-
Frame rebate	19	-
Flange width	-	24
Frame depth	-	35
Min. dimensions	min. W 200 x H 200	

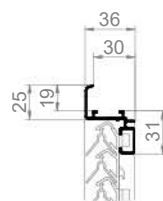

G 20V

Recessed wall louvre
with flange



F 20V

Window louvre

VENTILATION VALUES

Feature		STND	+OPT
Visual free area		95 %	95 %
Physical free area		34 %	34 %
Ce (higher is better)		0,155	0,149
Cd (higher is better)		0,155	0,149
K-FACTOR (lower is better)	INTAKE	41,62	45,04
	EXHAUST	41,62	45,04

STND and +OPT version: see page 5

Insect protection: standard stainless steel mesh 2.3 x 2.3 mm, optional stainless steel mesh 6 x 6 mm or stainless steel mesh 20 x 20 mm

WATER RESISTANCE

Air velocity	Class	
	STND	+OPT
0 m/s	A	A
0,5 m/s	B	A
1 m/s	C	B
1,5 m/s	D	B
2 m/s	D	C
2,5 m/s	D	D



→ Dimensions & order information: see page 51
→ Full specifications: see page 52

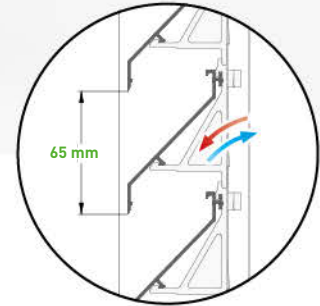

DucoGrille Classic 50Z

DucoGrille Classic 50Z consists of three different types: a recessed wall louvre (G with flange, N without flange) and an architectural window louvre (F). All types are manufactured from extruded aluminium sections. Insect mesh is fitted as standard. The “Z”-shaped louvre blade produces a sleek design.

FRAME TYPES AND DIMENSIONS

Dimensions in mm		G	N	F
Louvre pitch			65	
Installation depth		62	65	-
Frame rebate		48	0	-
Flange width		-	-	28
Frame depth		-	-	77
Min. dimensions	WIDTH	300		
	HEIGHT	300		350

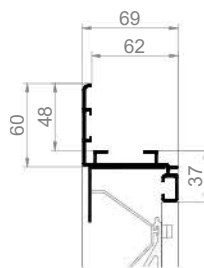

G 50Z

Recessed wall louvre
with flange

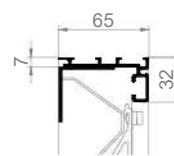

N 50Z

Recessed wall louvre
without flange

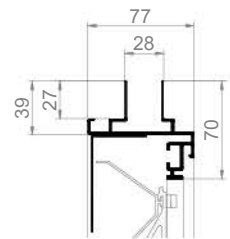

F 50Z

Window louvre

VENTILATION VALUES

Feature		STND	+OPT
Visual free area		75 %	75 %
Physical free area		47 %	47 %
Ce (higher is better)		0,232	0,207
Cd (higher is better)		0,263	0,266
K-FACTOR (lower is better)	INTAKE	18,58	23,34
	EXHAUST	14,46	14,13

WATER RESISTANCE

Air velocity	Class	
	STND	+OPT
0 m/s	C	A
0,5 m/s	C	B
1 m/s	C	B
1,5 m/s	D	C
2 m/s	D	C
2,5 m/s	D	D

STND and +OPT version: see page 5

Insect protection: standard stainless steel mesh 2.3 x 2.3 mm, optional stainless steel mesh 6 x 6 mm or stainless steel mesh 20 x 20 mm



→ Dimensions & order information: see page 51
→ Full specifications: see page 52

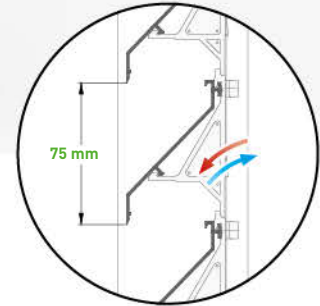

DucoGrille Classic 50/75Z

DucoGrille Classic 50/75Z consists of three different types: a recessed wall louvre (G with flange, N without flange) and an architectural window louvre (F). All types are manufactured from extruded aluminium sections. Insect mesh is fitted as standard. The “Z”-shaped louvre blade produces a sleek design.

FRAME TYPES AND DIMENSIONS

Dimensions in mm		G	N	F
Louvre pitch			75	
Installation depth		62	65	-
Frame rebate		48	0	-
Flange width		-	-	28
Frame depth		-	-	77
Min. dimensions	WIDTH	300		
	HEIGHT	300		350

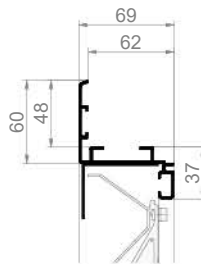

G 50/75Z
Recessed wall louvre
with flange

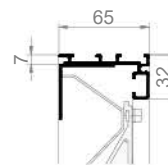

N 50/75Z
Recessed wall louvre
without flange

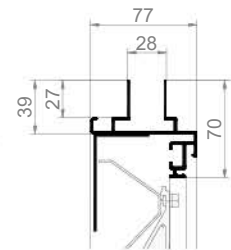

F 50/75Z
Window louvre

VENTILATION VALUES

Feature		STND	+OPT
Visual free area		80 %	80 %
Physical free area		49 %	49 %
Ce (higher is better)		0,239	0,219
Cd (higher is better)		0,278	0,288
K-FACTOR (lower is better)	INTAKE	17,51	20,85
	EXHAUST	12,94	12,06

STND and +OPT version: see page 5

Insect protection: standard stainless steel mesh 2.3 x 2.3 mm, optional stainless steel mesh 6 x 6 mm or stainless steel mesh 20 x 20 mm

WATER RESISTANCE

Air velocity	Class	
	STND	+OPT
0 m/s	C	A
0,5 m/s	C	B
1 m/s	C	B
1,5 m/s	D	C
2 m/s	D	C
2,5 m/s	D	D



→ Dimensions & order information: see page 51
→ Full specifications: see page 52



High Performance

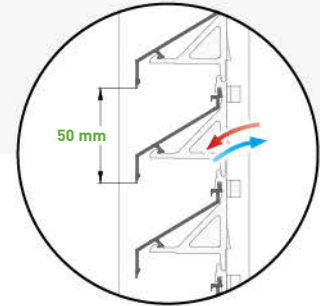
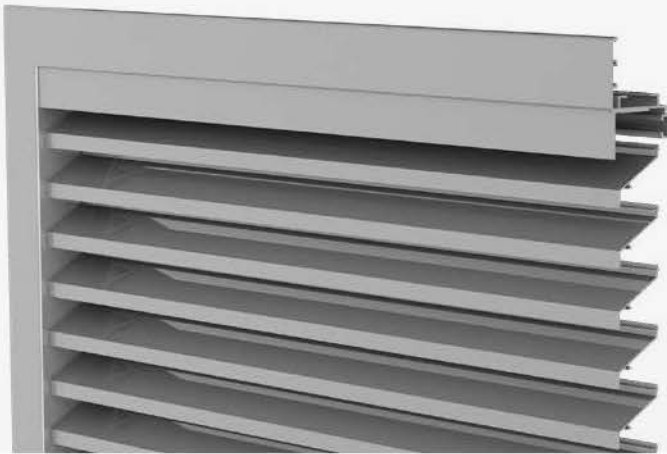

DucoGrille Classic 45HP

The DucoGrille Classic 45HP combines **excellent air flow** with a **“Z”-shaped louvre blade** for a sleek design. As a result, the DucoGrille Classic 45HP can be used for purge ventilation in projects with specific aesthetic requirements. All types are manufactured from extruded aluminium sections. Insect mesh is fitted as standard.

FRAME TYPES AND DIMENSIONS

Dimensions in mm	G	N	F
Louvre pitch	50		
Installation depth	62	65	-
Frame rebate	48	0	-
Flange width	-	-	28
Frame depth	-	-	77
Min. dimensions	min. W 250 x H 250		
Louvre blade holders	Plastic Metal Clip Reaction to fire A2-s1,d0 [EN13501-1]		

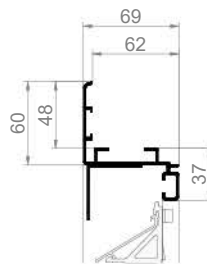

G 45HP
Recessed wall louvre
with flange

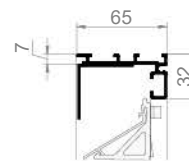

N 45HP
Recessed wall louvre
without flange

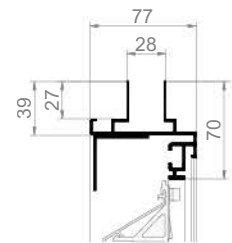

F 45HP
Window louvre

VENTILATION VALUES

Feature		STND	+OPT
Visual free area		70 %	70 %
Physical free area		60 %	60 %
Ce (higher is better)		0,341	0,295
Cd (higher is better)		0,365	0,369
K-FACTOR (lower is better)	INTAKE	8,60	11,49
	EXHAUST	7,51	7,34

WATER RESISTANCE

Air velocity	Class	
	STND	+OPT
0 m/s	C	B
0,5 m/s	C	B
1 m/s	D	C
1,5 m/s	D	C
2 m/s	D	C
2,5 m/s	D	C

STND and +OPT version: see page 5 Insect protection: standard stainless steel mesh 2.3 x 2.3 mm, optional stainless steel mesh 6 x 6 mm or stainless steel mesh 20 x 20 mm



→ Dimensions & order information: see page 51
→ Full specifications: see page 52

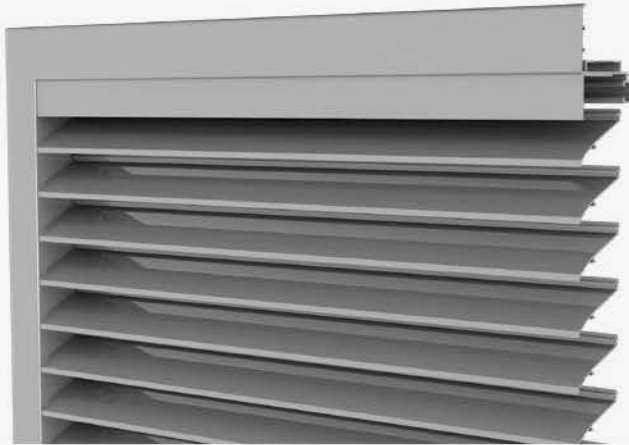

High Performance

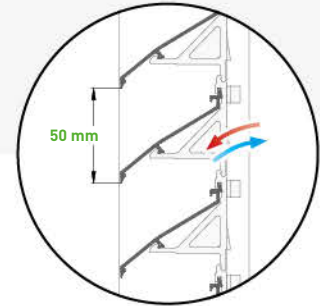

DucoGrille Classic 50HP

The DucoGrille Classic 50HP has been specially developed **for purge ventilation**. The uniquely shaped 'High Performance' louvre blade with a low resistance factor ensures **excellent air flow**. All types are manufactured from extruded aluminium sections. Insect mesh is fitted as standard.

FRAME TYPES AND DIMENSIONS

Dimensions in mm	G	N	F
Louvre pitch	50		
Installation depth	62	65	-
Frame rebate	48	0	-
Flange width	-	-	28
Frame depth	-	-	77
Min. dimensions	min. W 250 x H 250		
Louvre blade holders	Plastic Metal Clip Reaction to fire A2-s1,d0 (EN13501-1)		

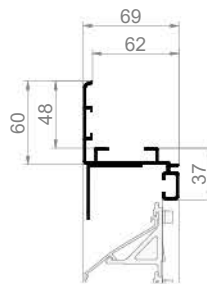

G 50HP
Recessed wall louvre
with flange

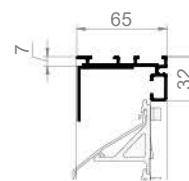

N 50HP
Recessed wall louvre
without flange

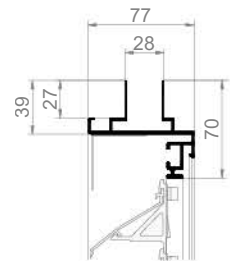

F 50HP
Window louvre

VENTILATION VALUES

Feature		STND	+OPT
Visual free area		88 %	88 %
Physical free area		68 %	68 %
Ce (higher is better)		0,399	0,352
Cd (higher is better)		0,392	0,415
K-FACTOR (lower is better)	INTAKE	6,28	8,07
	EXHAUST	6,51	5,81

WATER RESISTANCE

Air velocity	Class	
	STND	+OPT
0 m/s	C	B
0,5 m/s	C	B
1 m/s	C	B
1,5 m/s	D	C
2 m/s	D	C
2,5 m/s	D	C

STND and +OPT version: see page 5 Insect protection: standard stainless steel mesh 2.3 x 2.3 mm, optional stainless steel mesh 6 x 6 mm or stainless steel mesh 20 x 20 mm



→ Dimensions & order information: see page 51
→ Full specifications: see page 52



High Performance



Excellent water resistance

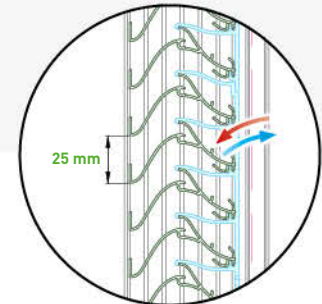

DucoGrille Classic 60HP

The DucoGrille Classic 60HP was specially developed for **purge ventilation**. The uniquely shaped 'High Performance' louvre blade with a low resistance factor provides **excellent water resistance (class A)**. All types are manufactured from extruded aluminium sections. Insect mesh is fitted as standard.

FRAME TYPES AND DIMENSIONS

Dimensions in mm		G	N	F
Louvre pitch		25		
Installation depth		76,5		
Frame rebate		33	0	-
Flange width		-	-	28 - 32
Frame depth		76,5		
Min. dimensions	WIDTH	200	300	
	HEIGHT	200	300	

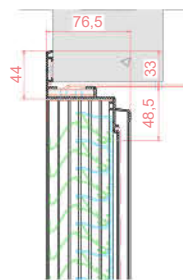

G 60HP
Recessed wall louvre
with flange

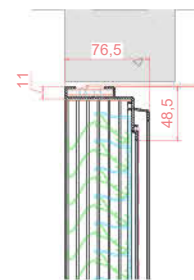

N 60HP
Recessed wall louvre
without flange

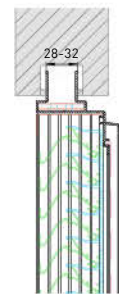

F 60HP
Window louvre

VENTILATION VALUES

Feature		STND	+OPT
Visual free area		60 %	60 %
Physical free area		50 %	50 %
Ce (higher is better)		0,200	0,197
Cd (higher is better)		0,252	0,253
K-FACTOR (lower is better)	INTAKE	25,00	25,77
	EXHAUST	15,75	15,62

WATER RESISTANCE

Air velocity	Class	
	STND	+OPT
0 m/s	A	A
0,5 m/s	A	A
1 m/s	A	A
1,5 m/s	A	A
2 m/s	A	A
2,5 m/s	C	A

STND and +OPT version: see page 5 Insect protection: standard stainless steel mesh 2.3 x 2.3 mm, optional stainless steel mesh 6 x 6 mm or stainless steel mesh 20 x 20 mm



→ Dimensions & order information: see page 51
→ Full specifications: see page 52



High Performance



Excellent water resistance

water resistance
CLASS A
up to 2.5 m/s



DucoGrille Classic 60HP Vertical

The DucoGrille Classic 60HP Vertical was specially developed for **purge ventilation**. DucoGrille Classic 60HP Vertical is a variant of the DucoGrille Classic 60HP, but with **vertical louvers**. The uniquely shaped 'High Performance' louver blade with a low resistance factor provides **excellent water resistance (class A)**. All types are manufactured from extruded aluminium sections. Insect mesh is fitted as standard.

FRAME TYPES AND DIMENSIONS

Dimensions in mm		G	N	F
Louvre pitch		25		
Installation depth		76,5		
Frame rebate		33	0	-
Flange width		-	-	28 - 32
Frame depth		76,5		
Min. dimensions	WIDTH	200	300	
	HEIGHT	200	300	

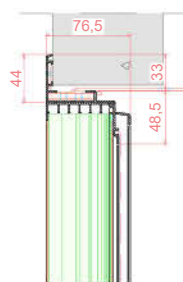

G 60HP Vertical

Recessed wall louvre with flange

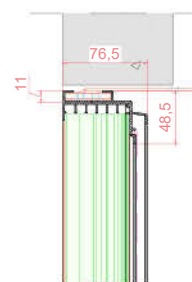

N 60HP Vertical

Recessed wall louvre without flange

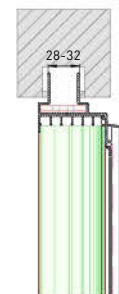

F 60HP Vertical

Window louvre

VENTILATION VALUES

Feature		STND	+OPT
Visual free area		60 %	n/a
Physical free area		50 %	n/a
Ce (higher is better)		0,193	n/a
Cd (higher is better)		0,243	n/a
K-FACTOR (lower is better)	INTAKE	26,85	n/a
	EXHAUST	16,94	n/a

STND and +OPT version: see page 5

Insect protection: standard stainless steel mesh 2,3 x 2,3 mm, optional stainless steel mesh 6 x 6 mm or stainless steel mesh 20 x 20 mm

WATER RESISTANCE

Air velocity	Class	
	STND	+OPT
0 m/s	A	n/a
0,5 m/s	A	n/a
1 m/s	A	n/a
1,5 m/s	A	n/a
2 m/s	A	n/a
2,5 m/s	A	n/a



→ Dimensions & order information: see page 51
→ Full specifications: see page 52



High Performance



Excellent water resistance

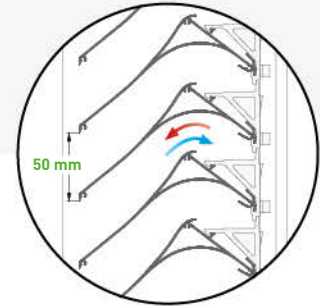

DucoGrille Classic 130HP

The DucoGrille Classic 130HP has been specially developed for **purge ventilation**. The uniquely shaped 'High Performance' louvre blade with a low resistance factor provides a combination of **very good air flow** together with **excellent water resistance (class A)**. All types are manufactured from extruded aluminium sections. Insect mesh is fitted as standard.

water resistance
CLASS A
up to 2.5 m/s



FRAME TYPES AND DIMENSIONS

Dimensions in mm	G	N
Louvre pitch	50	
Installation depth	158	165
Frame rebate	48	0
Min. dimensions	min. W 250 x H 250	
Louvre blade holders	Plastic	
	Metal Clip Reaction to fire A2-s1,d0 (EN13501-1)	



G 130HP
Recessed wall louvre
with flange

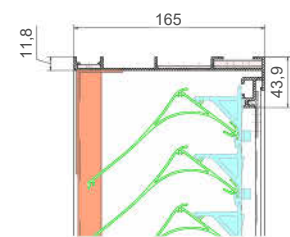

N 130HP
Recessed wall louvre
without flange

VENTILATION VALUES

Feature		STND	+OPT
Visual free area		88 %	n/a
Physical free area		70 %	n/a
Ce (higher is better)		0,333	n/a
Cd (higher is better)		0,284	n/a
K-FACTOR (lower is better)	INTAKE	9,02	n/a
	EXHAUST	12,40	n/a

WATER RESISTANCE

Air velocity	Class	
	STND	+OPT
0 m/s	A	n/a
0,5 m/s	A	n/a
1 m/s	A	n/a
1,5 m/s	A	n/a
2 m/s	A	n/a
2,5 m/s	A	n/a

STND and +OPT version: see page 5 Insect protection: standard stainless steel mesh 2.3 x 2.3 mm, optional stainless steel mesh 6 x 6 mm or stainless steel mesh 20 x 20 mm



→ Dimensions & order information: see page 51
→ Full specifications: see page 52



High Performance Good water resistance

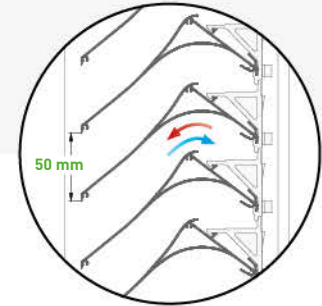

DucoGrille Classic 130HP Basic

The DucoGrille Classic 130HP Basic has been specially developed for **purge ventilation**. The uniquely shaped 'High Performance' louvre blade with a low resistance factor provides a combination of **very good airflow** together with **good water resistance**. All types are manufactured from extruded aluminium sections. Insect mesh is fitted as standard.

FRAME TYPES AND DIMENSIONS

Dimensions in mm		G	N
Louvre pitch		50	
Installation depth		158	165
Frame rebate		48	0
Min. dimensions		min. W 250 x H 250	
Louvre blade holders		Plastic	
		Metal Clip Reaction to fire A2-s1,d0 (EN13501-1)	

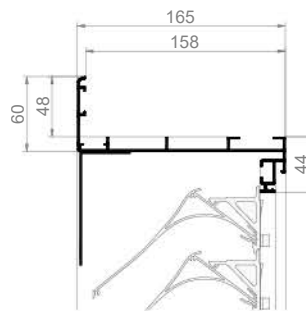

G 130HP Basic
Recessed wall louvre
with flange

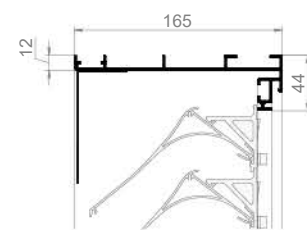

N 130HP Basic
Recessed wall louvre
without flange

VENTILATION VALUES

Feature		STND	+OPT
Visual free area		88 %	n/a
Physical free area		70 %	n/a
Ce (higher is better)		0,321	n/a
Cd (higher is better)		0,276	n/a
K-FACTOR (lower is better)	INTAKE	9,70	n/a
	EXHAUST	13,13	n/a

WATER RESISTANCE

Air velocity	Class	
	STND	+OPT
0 m/s	A	n/a
0,5 m/s	A	n/a
1 m/s	A	n/a
1,5 m/s	B	n/a
2 m/s	B	n/a
2,5 m/s	C	n/a

STND and +OPT version: see page 5 Insect protection: standard stainless steel mesh 2.3 x 2.3 mm, optional stainless steel mesh 6 x 6 mm or stainless steel mesh 20 x 20 mm



→ Dimensions & order information: see page 51
→ Full specifications: see page 52



Good water resistance

Penetration safe

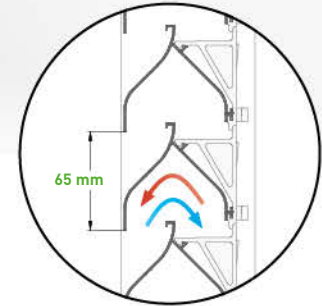

DucoGrille Classic 70V

DucoGrille Classic G 70V is a recessed wall louvre manufactured from extruded aluminium sections. Insect mesh is fitted as standard. The unique “V”-shaped blade ensures better water resistance and makes the louvre grille ‘penetration-proof’ and difficult to see through from the outside.

FRAME TYPES AND DIMENSIONS

Dimensions in mm		G
Louvre pitch		65
Installation depth		82
Frame rebate		48
Min. dimensions	min. W 300 x H 300	

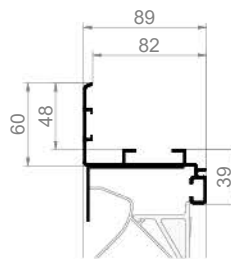

G 70V
Recessed wall louvre
with flange

VENTILATION VALUES

Feature		STND	+OPT
Visual free area		65 %	65 %
Physical free area		36 %	36 %
Ce (higher is better)		0,117	0,111
Cd (higher is better)		0,109	0,103
K-FACTOR (lower is better)	INTAKE	73,05	81,16
	EXHAUST	84,17	94,26

WATER RESISTANCE

Air velocity	Class	
	STND	+OPT
0 m/s	B	A
0,5 m/s	B	B
1 m/s	B	B
1,5 m/s	C	C
2 m/s	D	D
2,5 m/s	D	D

STND and +OPT version: see page 5 Insect protection: standard stainless steel mesh 2.3 x 2.3 mm, optional stainless steel mesh 6 x 6 mm or stainless steel mesh 20 x 20 mm



→ Dimensions & order information: see page 51
→ Full specifications: see page 52



Good water resistance



Penetration safe

DucoGrille Classic 70V Vertical

DucoGrille Classic G 70V Vertical is a recessed wall louvre made of aluminium extrusion profiles. DucoGrille Classic G 70V Vertical is a variant of the DucoGrille Classic G 70V, but with vertical louvres. Insect mesh is fitted as standard. The unique **“V”-shaped blade** ensures better water resistance and makes the louvre grille ‘penetration-proof’ and difficult to see through from the outside.

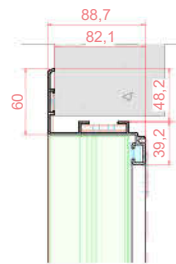

G 70V Vertical
Recessed wall louvre
with flange

FRAME TYPES AND DIMENSIONS

Dimensions in mm	G
Louvre pitch	65
Installation depth	82
Frame rebate	48
Min. dimensions	min. W 300 x H 300

VENTILATION VALUES

Feature		STND	+OPT
Visual free area		65 %	65 %
Physical free area		36 %	36 %
Ce (higher is better)		0,117	0,111
Cd (higher is better)		0,109	0,103
K-FACTOR (lower is better)	INTAKE	73,05	81,16
	EXHAUST	84,17	94,26

WATER RESISTANCE

Air velocity	Class	
	STND	+OPT
0 m/s	A	A
0,5 m/s	A	A
1 m/s	A	A
1,5 m/s	C	A
2 m/s	C	A
2,5 m/s	D	C

STND and +OPT version: see page 5

Insect protection: standard stainless steel mesh 2.3 x 2.3 mm, optional stainless steel mesh 6 x 6 mm or stainless steel mesh 20 x 20 mm



→ Dimensions & order information: see page 51
→ Full specifications: see page 52



DucoGrille **Classic** 20Z

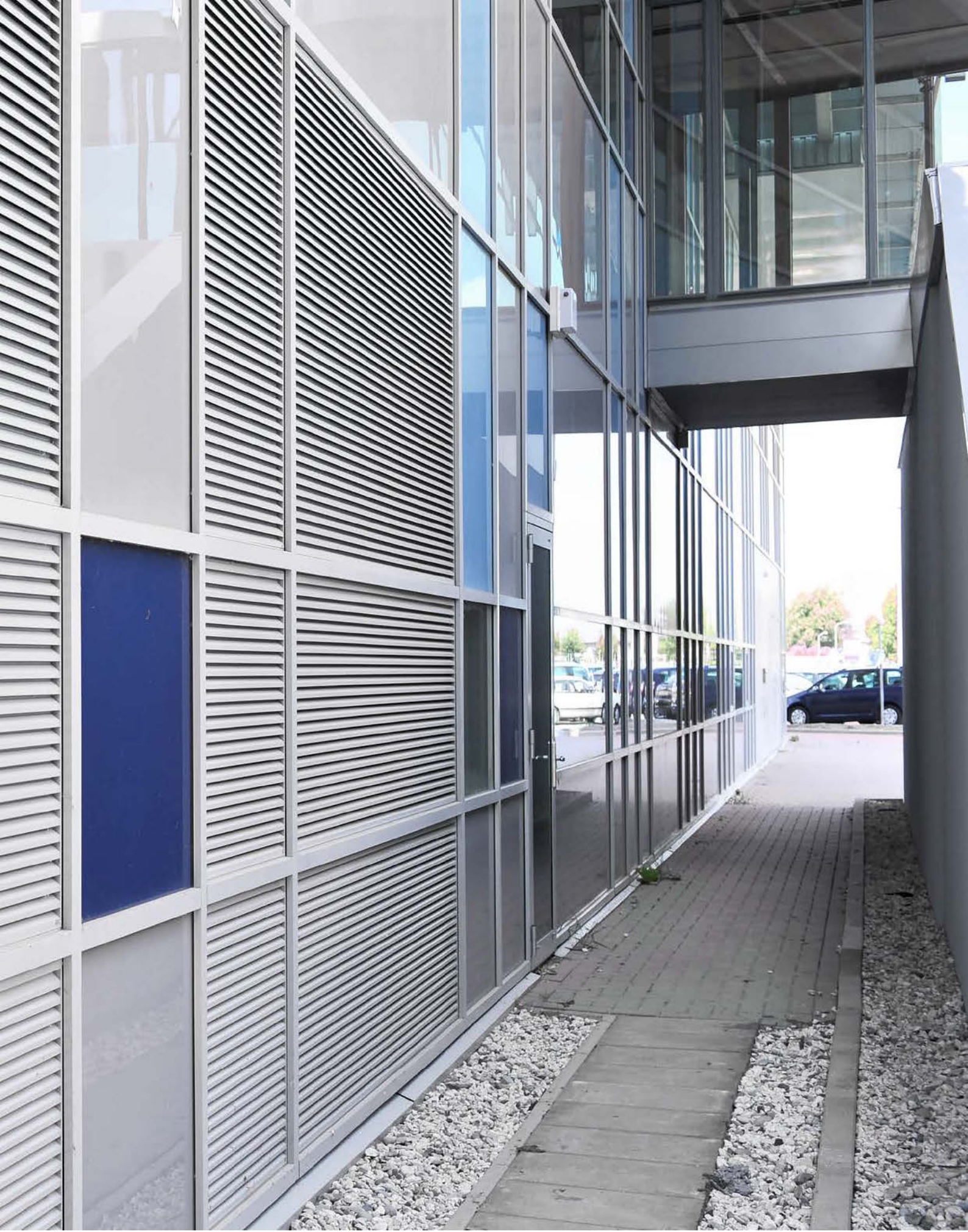



Suitable for moderate noise levels

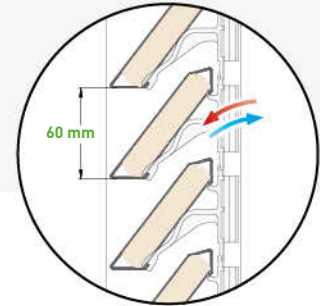

75L

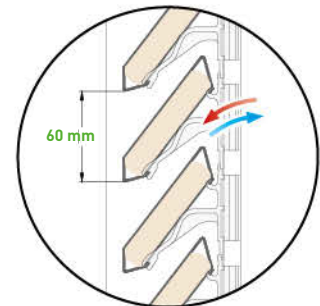

75Z

DucoGrille Acoustic 75Z & 75L

DucoGrille Acoustic G 75Z & G 75L are sound-absorbing recessed wall louvres manufactured from extruded aluminium sections. One type of louvre blade offers the option of **two different looks**: Z and L. The louvre blades have **sound-absorbing, non-combustible mineral wool** inside.

FRAME TYPES AND DIMENSIONS

Dimensions in mm	G
Louvre pitch	60
Installation depth	82
Frame rebate	48
Min. dimensions	min. W 250 x H 250

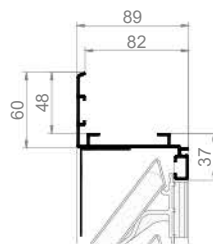

G 75Z
Recessed wall louvre
with flange



G 75L
Recessed wall louvre
with flange

SOUND ABSORPTION

Attenuation value Rw (C;Ctr) in dB	
75Z	75L
6 (0;-1)	6 (0;-2)

VENTILATION VALUES

Feature	75Z		75L		
	STND	+OPT	STND	+OPT	
Visual free area	76 %	76 %	95 %	95 %	
Physical free area	28 %	28 %	28 %	28 %	
Ce (higher is better)	0,243	0,196	0,246	0,209	
Cd (higher is better)	0,214	0,182	0,287	0,254	
K-FACTOR (lower is better)	INTAKE	16,94	26,03	16,52	22,89
	EXHAUST	21,84	30,19	12,14	15,50

WATER RESISTANCE

Air velocity	Class			
	75Z		75L	
	STND	+OPT	STND	+OPT
0 m/s	B	B	B	B
0,5 m/s	B	B	C	B
1 m/s	C	C	C	C
1,5 m/s	D	C	D	D
2 m/s	D	D	D	D
2,5 m/s	D	D	D	D

STND and +OPT version: see page 5 Insect protection: standard stainless steel mesh 2.3 x 2.3 mm, optional stainless steel mesh 6 x 6 mm or stainless steel mesh 20 x 20 mm



→ Dimensions & order information: see page 51
→ Full specifications: see page 52

→ STND and +OPT version: see page 5



Suitable for high noise levels

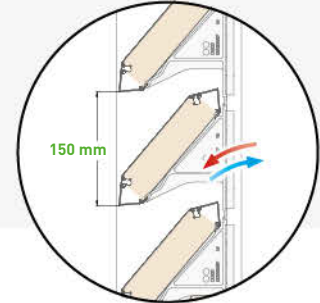

DucoGrille Acoustic 150

The DucoGrille Acoustic G150 / N150 is a sound absorbing recessed wall louvre manufactured from extruded aluminium sections. The louvre blades have **sound-absorbing, non-combustible mineral wool** inside. Thanks to its heavy-duty construction, the DucoGrille Acoustic G150 / N150 has a **high attenuation value plus a low resistance factor** (and consequently better flow rates).

FRAME TYPES AND DIMENSIONS

Dimensions in mm	G	N
Louvre pitch	150	
Installation depth	158	165
Frame rebate	48	0
Min. dimensions	min. W 250 x H 250	

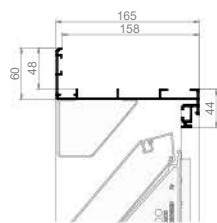

G 150
Recessed wall louvre
with flange

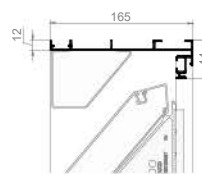

N 150
Recessed wall louvre
without flange

SOUND ABSORPTION

Attenuation value Rw (C;Ctr) in dB
 11 (-1;-2)

VENTILATION VALUES

Feature		STND	+OPT
Visual free area		74 %	n/a
Physical free area		35 %	n/a
Ce (higher is better)		0,295	n/a
Cd (higher is better)		0,296	n/a
K-FACTOR (lower is better)	INTAKE	11,49	n/a
	EXHAUST	11,41	n/a

WATER RESISTANCE

Air velocity	Class	
	STND	+OPT
0 m/s	B	n/a
0,5 m/s	C	n/a
1 m/s	C	n/a
1,5 m/s	C	n/a
2 m/s	D	n/a
2,5 m/s	D	n/a

STND and +OPT version: see page 5 Insect protection: standard stainless steel mesh 2.3 x 2.3 mm, optional stainless steel mesh 6 x 6 mm or stainless steel mesh 20 x 20 mm



→ Dimensions & order information: see page 51
→ Full specifications: see page 52



Fall-through protection



Impact protection



Suitable for high noise levels

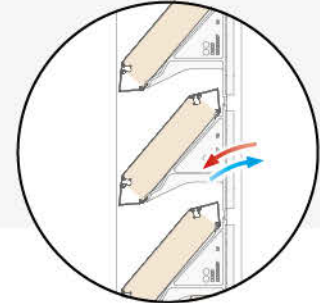

Duco **Acoustic Panel**

Duco Acoustic Panel is a sound absorbing recessed mounted wall louvre, manufactured from extruded aluminium sections. It is extremely suitable for housing and residential applications. The Acoustic 150 louvre blades feature sound-absorbing, non-combustible mineral wool and provide an **excellent sound reduction index**. This custom-made module is available in two variants: **Acoustic Panel 150** and **Acoustic Panel 300** for very high noise exposure. With its double row of louvre blades, the Duco Acoustic Panel 300 offers a **sound reduction index $R_w (C;Ctr)$ of no less than 17 (-1;-4) dB**.

Duco Acoustic Panel grilles meet the BS6180 standard (class XI) for **fall-through protection** and class 5 of EN13049 for **impact protection**. See page 46-47 for more information.

attenuation value
17 dB
with Acoustic Panel 300

FRAME TYPES AND DIMENSIONS

Dimensions in mm	150	300
	Louvre pitch	130
Installation depth	158	303
Frame rebate	37	
Min. dimensions	min. W 250 x H 280	



150

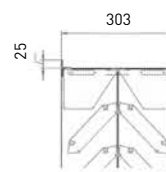

300

SOUND ABSORPTION

Attenuation value $R_w (C;Ctr)$ in dB
150: 11 (-1;-2) 300: 17 (-1;-4)

VENTILATION VALUES

Feature	150		300		
	STND	+OPT	STND	+OPT	
Visual free area	71 %	71 %	71 %	71 %	
Physical free area	31 %	31 %	31 %	31 %	
Ce (higher is better)	0,251	0,236	0,194	0,177	
Cd (higher is better)	0,248	0,248	0,191	0,191	
K-FACTOR (lower is better)	INTAKE	15,87	17,95	26,57	31,92
	EXHAUST	16,26	16,26	27,41	27,41

WATER RESISTANCE

Air velocity	Class			
	150		300	
	STND	+OPT	STND	+OPT
0 m/s	C	B	C	B
0,5 m/s	D	C	D	C
1 m/s	D	D	D	D
1,5 m/s	D	D	D	D
2 m/s	D	D	D	D
2,5 m/s	D	D	D	D

STND and +OPT version: see page 5 Insect protection: optional stainless steel mesh 2.3 x 2.3 mm, stainless steel mesh 6 x 6 mm or stainless steel mesh 20 x 20 mm



→ Dimensions & order information: see page 51
→ Full specifications: see page 52

→ Impact & fall-through protection: see page 46-47



Duco **Acoustic Panel**

State | Amsterdam (Netherlands)



DucoGrille Transfer

This transfer grille with 20V louvre blades can easily be installed in **doors and walls**. The **frame depth can be adjusted**. The grille can be fitted **with or without a counterframe**. The DucoGrille Transfer is ideally suited for **larger air flows** between interior spaces, but can also be used between interior and exterior spaces (e.g. exterior doors).

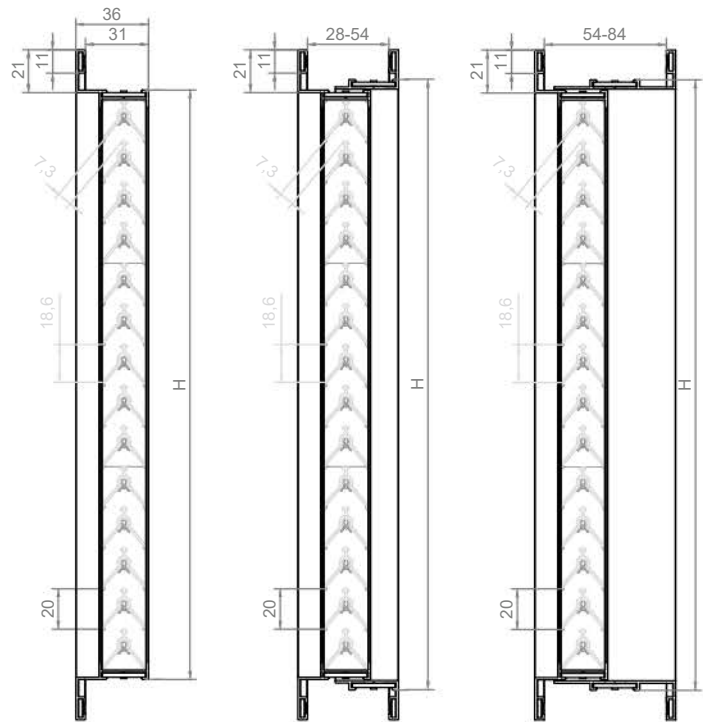

FRAME TYPES AND DIMENSIONS

Dimensions in mm

Louvre pitch	20
Recess depth (with counterframe)	28 - 84 mm
Frame rebate	21 mm

Without counterframe

With counterframe
28-54 mm depth

With counterframe
54-84 mm depth

VENTILATION VALUES

Feature		STND	+OPT
Visual free area		95 %	n/a
Physical free area		34 %	n/a
Ce (higher is better)		0,155	n/a
Cd (higher is better)		0,155	n/a
K-FACTOR (lower is better)	INTAKE	41,62	n/a
	EXHAUST	41,62	n/a

STND and +OPT version: see page 5

WATER RESISTANCE

Air velocity	Class	
	STND	+OPT
0 m/s	A	n/a
0,5 m/s	B	n/a
1 m/s	C	n/a
1,5 m/s	D	n/a
2 m/s	D	n/a
2,5 m/s	D	n/a



Suitable for moderate noise levels

DucoGrille Transfer Acoustic

DucoGrille Transfer Acoustic is an **acoustic transfer grille** which fits easily into doors and walls. The frame depth can be adjusted. The grille is available **with or without a counterframe**. Thanks to the acoustic louvre blades, the DucoGrille Transfer Acoustic is ideally suited for use between multiple internal and external spaces (e.g. outside doors).

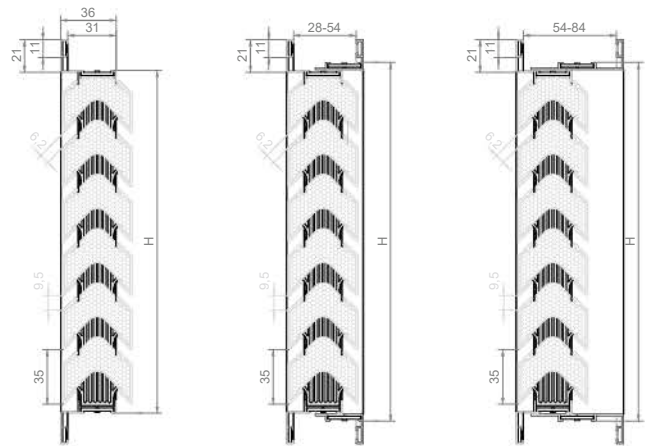

Without counterframe

With counterframe
28-54 mm depth

With counterframe
54-84 mm depth

VENTILATION VALUES

Feature	STND	+OPT
Visual free area	27 %	n/a
Physical free area	18 %	n/a
Ce (higher is better)	0,083	n/a
Cd (higher is better)	0,082	n/a
K-FACTOR (lower is better)	INTAKE	145,16
	EXHAUST	148,72

FRAME TYPES AND DIMENSIONS

Dimensions in mm

Louvre pitch	35
Recess depth (with counterframe)	28 - 84 mm
Frame rebate	21 mm

SOUND ABSORPTION

Frequency (Hz)	Dimensions, WxH in mm				
	245x115	320x220	440x325	440x430	765x535
63	6,0	3,8	1,6	2,5	2,3
125	9,9	8,1	6,1	6,6	5,4
250	18,8	11,8	8,1	8,5	7,6
500	11,3	5,9	4,0	4,1	4,3
1000	9,1	6,5	3,3	4,9	4,8
2000	15,7	12,4	9,0	10,4	10,9
4000	24,7	21,9	18,7	20,1	20,7
Rw (C;Ctr)	13(-1;-2)	9(0;-1)	6(0;-1)	7(0;-1)	7(0;-1)

WATER RESISTANCE

Air velocity	Class	
	STND	+OPT
0 m/s	A	n/a
0,5 m/s	A	n/a
1 m/s	C	n/a
1,5 m/s	D	n/a
2 m/s	D	n/a
2,5 m/s	D	n/a

STND and +OPT version: see page 5



In both
CONVENTIONAL
and **CURTAIN**
WALLS

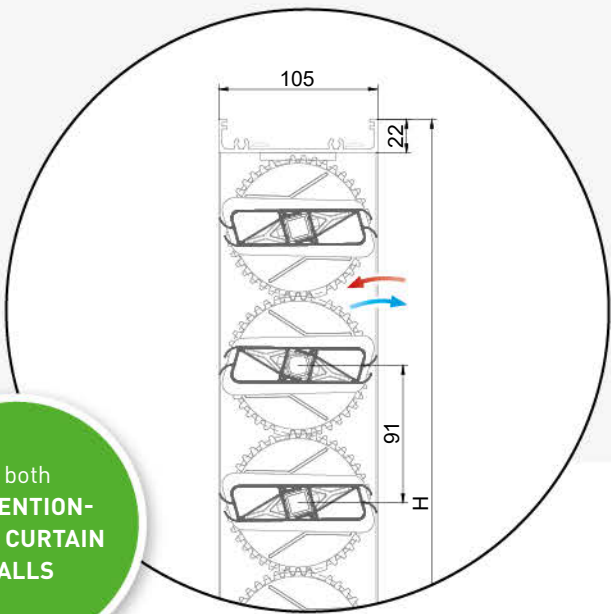

DucoGrille Close 105

The DucoGrille Close 105 is a **motorised multileaf damper** with large air passage, tailor-made for offices and schools. The multileaf damper can be used both as a supply and exhaust grille. In the first case, the DucoGrille Close 105 can be built into a **wall or curtain wall** and a wall louvre on both sides, which may or may not be burglar resistant, ensures an aesthetic finish. With a limited depth of just 105 mm, the multileaf damper can easily be installed in smaller rooms, both horizontally and vertically.

Moreover, the multileaf damper can also serve as an **adjustable central exhaust unit**, for example in combination with DUCO's roof turrets. Thanks to the high airflow rate, the DucoGrille Close 105 is also ideal for use in providing intensive ventilation or as part of the **(night) cooling systems** of a building.

The DucoGrille Close 105 can be fitted with **different types of motor** (including **Spring Return** motors as well).



→ DucoGrille Close 105 louvers in closed position



→ DucoGrille Close 105 possibility of recessed curtain wall

VENTILATION VALUES

Feature		STND	+OPT
Visual free area		74 %*	n/a
Physical free area		74 %*	n/a
Ce (higher is better)		0,624*	n/a
Cd (higher is better)		0,624*	n/a
K-FACTOR (lower is better)	INTAKE	2,57*	n/a
	EXHAUST	2,57*	n/a

* Values measured without internal and external louvre grille.

STND and +OPT version: see page 5

WATER RESISTANCE

Air velocity	Class	
	STND	+OPT
0 m/s	n/a	n/a
0,5 m/s	n/a	n/a
1 m/s	n/a	n/a
1,5 m/s	n/a	n/a
2 m/s	n/a	n/a
2,5 m/s	n/a	n/a



→ Dimensions & order information: see page 51
→ Full specifications: see page 52

FRAME TYPES AND DIMENSIONS

Dimensions	min. 258 mm up to max. of 3000 mm (incremental by 1 mm) Width and height interdependent, see graph opposite
Depth	105 mm
Louvre pitch	91 mm
Airflow	805 l/s/m ² at 1 Pa 1200 l/s/m ² at 2 Pa
Air density (in closed position)	Qn50 = 0.79 m ³ /h/m
Water-tightness (in closed position)	Watertight (EN 1027)
Insulation value	U < 1 W/m ² K
Motor noise	35 dB(A) - 45 dB(A)
Operating temperature	-25 °C up to +60 °C
Control	GBS
Motors	Different types, please refer to the technical data sheet at www.duco.eu .

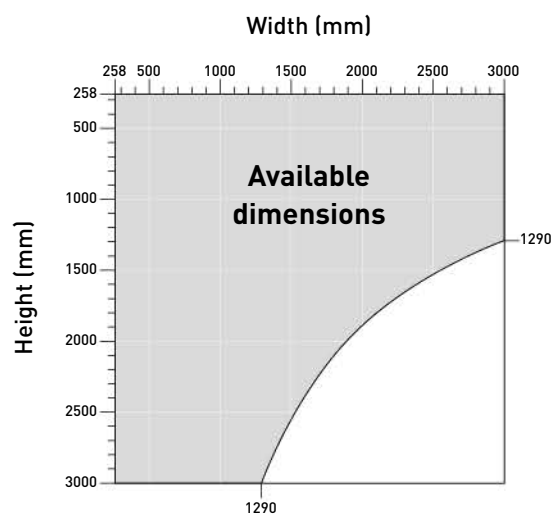

1 3

Louvre grille

The DucoGrille Close 105 can be combined with **DucoGrille Solid** and **DucoGrille Classic** louvre grilles on the inside and outside.

2

Close 105 multileaf damper

The DucoGrille Close 105 can be controlled fully automatically.



PRE-ASSEMBLY

The **DucoGrille Close 105** is available 'pre-assembled' with the **DucoGrille Solid 30Z** external louvre grille in two types: **G 30Z** (recessed wall louvre with flange) and **F 30Z** (window louvre). This pre-assembled external louvre grille with multileaf damper can be installed quickly and easily.





MANUAL
OR
MOTORISED

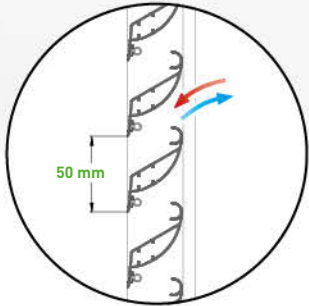

DucoGrille Close 35Z

DucoGrille Close G 35Z and N 35Z are closable recessed wall louvres manufactured from extruded aluminium sections. The DucoGrille Close is also available as a closable window louvre (F 35Z), ideal when using Night Cooling. The unique “Z”-shaped louvre blades provide adjustable ventilation via manual or electric operation.



→ Manual stepless operation: left, centre or right of the grille, as preferred

FRAME TYPES AND DIMENSIONS

		Dimensions in mm		
		G	N	F
Louvre pitch		50		
Installation depth		45	45	-
Frame rebate		20	0	-
Flange width		-	-	24/28
Frame depth		-	-	45
Minimum height	MANUAL OPERATION	224*	224*	264*
	ELECTRONIC OPERATION	524*	524*	564*

* height to be determined in 50-mm steps

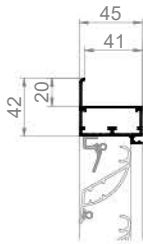

G 35Z
Recessed wall louvre with flange

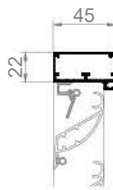

N 35Z
Recessed wall louvre without flange

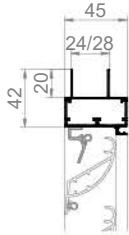

F 35Z
Window louvre

VENTILATION VALUES

Feature		STND	+OPT
Visual free area		51 %	n/a
Physical free area		39 %	n/a
Ce (higher is better)		0,182	n/a
Cd (higher is better)		0,206	n/a
K-FACTOR (lower is better)	INTAKE	30,19	n/a
	EXHAUST	23,56	n/a

STND and +OPT version: see page 5

Insect protection: standard stainless steel mesh 2.3 x 2.3 mm, optional stainless steel mesh 6 x 6 mm or stainless steel mesh 20 x 20 mm

WATER RESISTANCE

Air velocity	Class	
	STND	+OPT
0 m/s	B	n/a
0,5 m/s	B	n/a
1 m/s	C	n/a
1,5 m/s	D	n/a
2 m/s	D	n/a
2,5 m/s	D	n/a



→ Dimensions & order information: see page 51
→ Full specifications: see page 52

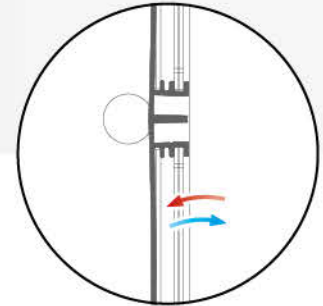

DucoGrille Close M 100

DucoGrille Close M 100 is a closable surface mounted internal louvre grille manufactured from extruded aluminium sections. The plastic slides provide **adjustable ventilation**. The DucoGrille Close M 100 is available as standard with heights of 200 or 300 mm and the width can vary up to a maximum of 1,000 mm.

DIMENSIONS

Frame depth	13 mm
Height of the grille	200 or 300 mm
Width of the grille	max.: 1000 mm

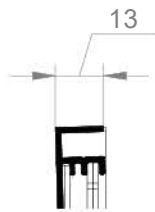

M 100
Surface mounted wall louvre

VENTILATION VALUES

Feature		STND	+OPT
Visual free area		28 %	n/a
Physical free area		28 %	n/a
Ce (higher is better)		0,106	n/a
Cd (higher is better)		0,106	n/a
K-FACTOR (lower is better)	INTAKE	89,00	n/a
	EXHAUST	89,00	n/a

AIR FLOW

Dimension	200 x 200	300 x 300
	Airflow at 1 Pa (m ³ /h)	19,76
Airflow at 2 Pa (m ³ /h)	27,96	62,90

INSECT SCREEN



STND and +OPT version: see page 5



→ Dimensions & order information: see page 51
→ Full specifications: see page 52

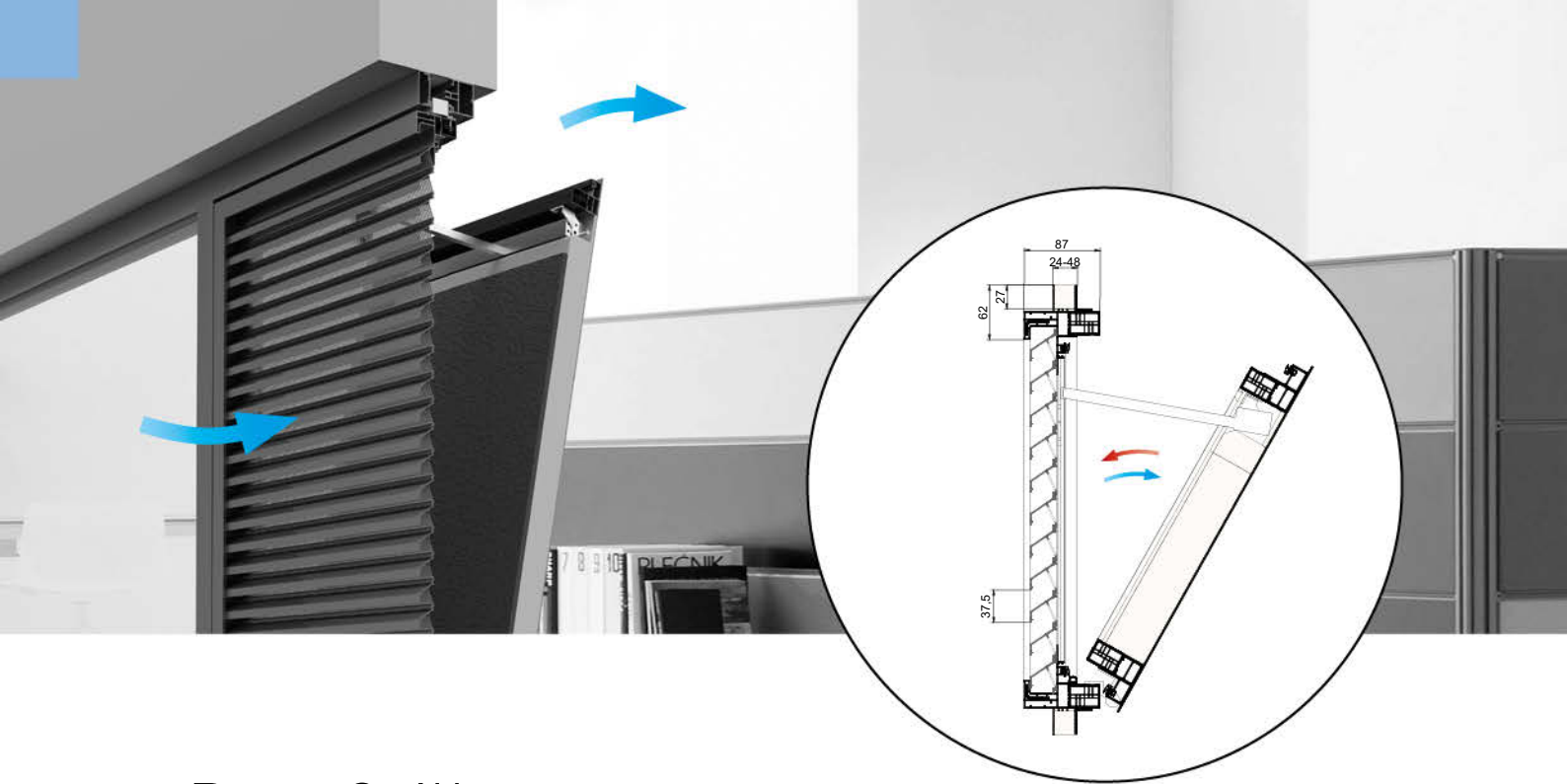

DucoGrille NightVent

The DucoGrille NightVent is a **glass-replacing ventilation hatch** that provides efficient cooling of any building thanks to the supply of **large ventilation flow rates**.

The ventilation hatch consists of **a single module**, although it contains two essential components. From outside, the DucoGrille NightVent is protected by a window louvre with perforated louvre blades (**DucoGrille Solid 30Z P1**) that act as an insect screen. On the inside, **an insulated opening panel** with a flat-finished inner panel makes for easy integration into the interior. In addition, the **acoustic attenuation** ensures that the thermal value of the ventilation hatch is comparable to that of a closed window.

The ventilation hatch can be **hinged horizontally or vertically**. The inner and outer panels can be finished in various colours. DucoGrille NightVent is available in **motorised and manual versions**.

The DucoGrille NightVent has been tested under the applicable European regulations by means of intensive tests covering wind and water resistance. In addition, the external louvre grille is also available in a vandal-proof or burglary-resistant version **up to RC2 class**.

VENTILATION VALUES

Feature		STND	+OPT
Visual free area		60 %	n/a
Physical free area		34 %	n/a
Ce (higher is better)		0,202	n/a
Cd (higher is better)		0,202	n/a
K-FACTOR (lower is better)	INTAKE	24,51	n/a
	EXHAUST	24,51	n/a

STND and +OPT version: see page 5

WATER RESISTANCE

Air velocity	Class	
	STND	+OPT
0 m/s	A	n/a
0,5 m/s	B	n/a
1 m/s	C	n/a
1,5 m/s	D	n/a
2 m/s	D	n/a
2,5 m/s	D	n/a

INSECT SCREEN

Fine punching keeps insects out. Stainless steel mesh can be fitted as an option.

DIMENSIONS AND SPECIFICATIONS



Motorised

Manual

Louvre pitch	37,5 mm	
Flange width	24 / 28 / 32 / 36 / 40 / 44 / 48	
Frame depth	115 mm	
Airflow	369 l/s/m ² at 2 Pa	
Air density (when closed)	Qn50 = 4,5 m ³ /h/m ²	
Water resistance (when closed)	Class 9a (EN 12208-EN1027)	
Attenuation value 	Rw open position [C;Ctr] = 10 [0,-1] dB Rw closed position [C;Ctr] = 33 [-1,-4] dB	
Insulation value	U = 1.5 W/m ² K	
Motor noise	< 35 dB (A)	n/a
Operating temperature	-25 °C up to +60 °C	n/a
Min. / max. dimensions	see tables on p. 40	
Operation		

If a motorised system is chosen, a remote control can open / close the ventilation hatch, alternatively the ventilation hatch can be linked to the building management system (BMS).



With the manual version, the ventilation hatch is fitted with one or two handles.

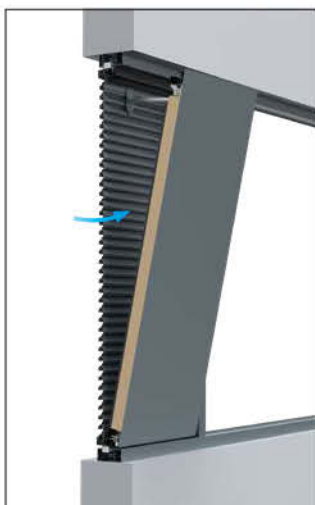

→ Inside view



→ Outside view



BURGLAR RESISTANT

The DucoGrille NightVent is vandal-proof and can optionally be burglar resistant up to RC2 class (according to NEN 5096:2012 & EN 1627:2011).



→ Dimensions & order information: see page 51
→ Full specifications: see page 52



DucoGrille **NightVent**

Ceratec | Comines-Warneton (Belgium)



Duco **Roof Turret Solid 30Z**

Duco Roof Turret Solid 30Z is an aluminium roof cowl. It provides aesthetic concealment of air vents. The roof cowl also ensures adequate **purge ventilation** of the screened areas and can be used in almost **all projects**. The perforated Solid 30Z louvre blades are the ideal solution for both insect resistance and ventilation capacity. Thanks to the large punching (P2), this **small roof cowl** achieves **high ventilation values**. The roof turrets are **made to measure** and provided with a sill at the bottom and a cover plate on top.

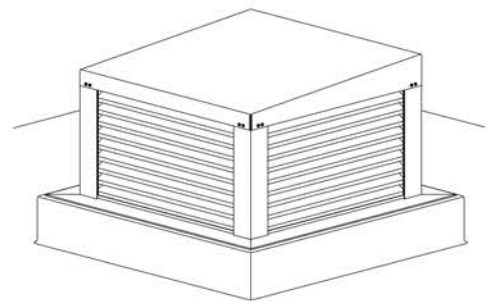

DIMENSIONS

Louvre pitch	37,5 mm
Roof turret length	Min. 200 mm - Max. 2630 mm (to be coupled)
Roof turret width	Min. 200 mm - Max. 1180 mm (to be coupled)
Roof turret height	Min. 255 mm - max. 1600 mm

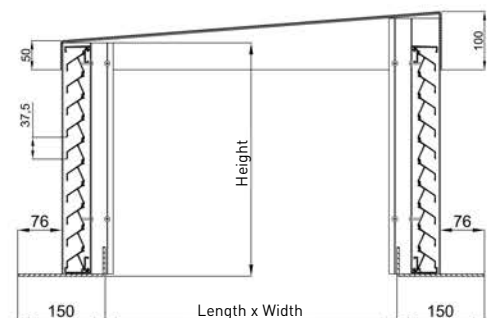

VENTILATION VALUES

Feature		P1	P2	P2 + ECG*
		STND	STND	STND
Visual free area		60 %	86 %	86 %
Physical free area		34 %	48 %	48 %
Ce (higher is better)		0,243	0,258	0,179
Cd (higher is better)		0,234	0,253	0,202
K-FACTOR (lower is better)	INTAKE	16,94	15,02	31,21
	EXHAUST	18,26	15,62	24,51

STND and +OPT version: see page 5

*ECG = Eggcrate grille (see page 43)

WATER RESISTANCE

Air velocity	Class		
	P1	P2	P2 + ECG*
	STND	STND	STND
0 m/s	B	C	A
0,5 m/s	C	C	A
1 m/s	C	C	A
1,5 m/s	D	D	B
2 m/s	D	D	C
2,5 m/s	D	D	C

Sill profile

The **Duco Roof Turret Solid 30Z** also exists as a variant with sill profile. The sill profile ensures **better water drainage**. The sill profile allows the roof covering to be completely concealed. This provides an **aesthetic finish**. It also offers more placement options.



OPTIONS DUCO ROOF TURRET SOLID 30Z

DucoGrille Close 105

The DucoGrille Close 105 can, as an option, be integrated in the roof turret, thereby ensuring a controlled air supply or extraction. More information about the DucoGrille Close 105 can be found on page 34.

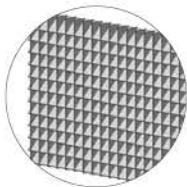
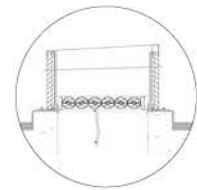

Eggcrate grille

The Duco Roof Turret Solid 30Z is available with an optional Eggcrate grille, which provides even better water resistance (combination with the P2 louvre blades).



VENTILATIVE COOLING

'Free cooling' by means of purge ventilation

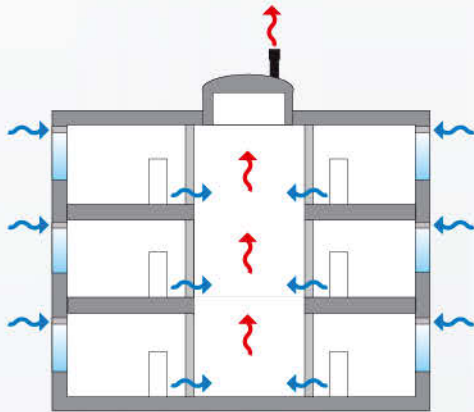

Airtight construction and good insulation not only result in lower heat demand, they also increase the demand for **cooling in a building**. Certainly during the warmer (summer) months, the indoor temperature can rise quickly. **Summer comfort** is therefore increasingly being included in the design requirements of buildings.

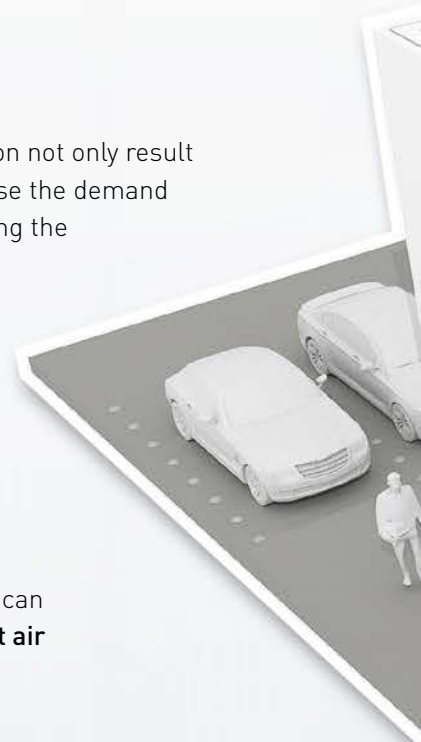

This is because by using **high flow rates** of outside air (purge ventilation), a building can achieve optimum cooling using ventilative cooling (free cooling). That means **without air conditioning** or other artificial means, provided one or two guidelines are followed:

- A** Always use ventilative cooling combined with **good exterior solar shading**.
- B** When designing the building, allow for **sufficient thermal mass** in the building to store the cooling effects of the outside air.
- C** Use the **correct pressure drop** when sizing the supply grilles.

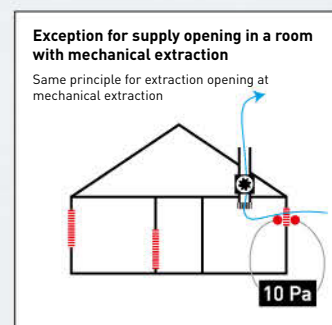
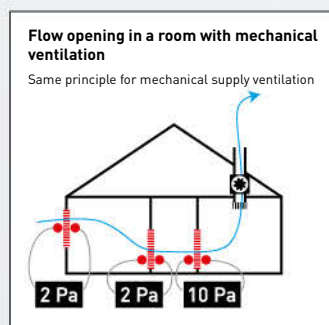
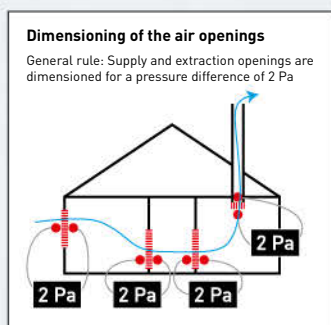

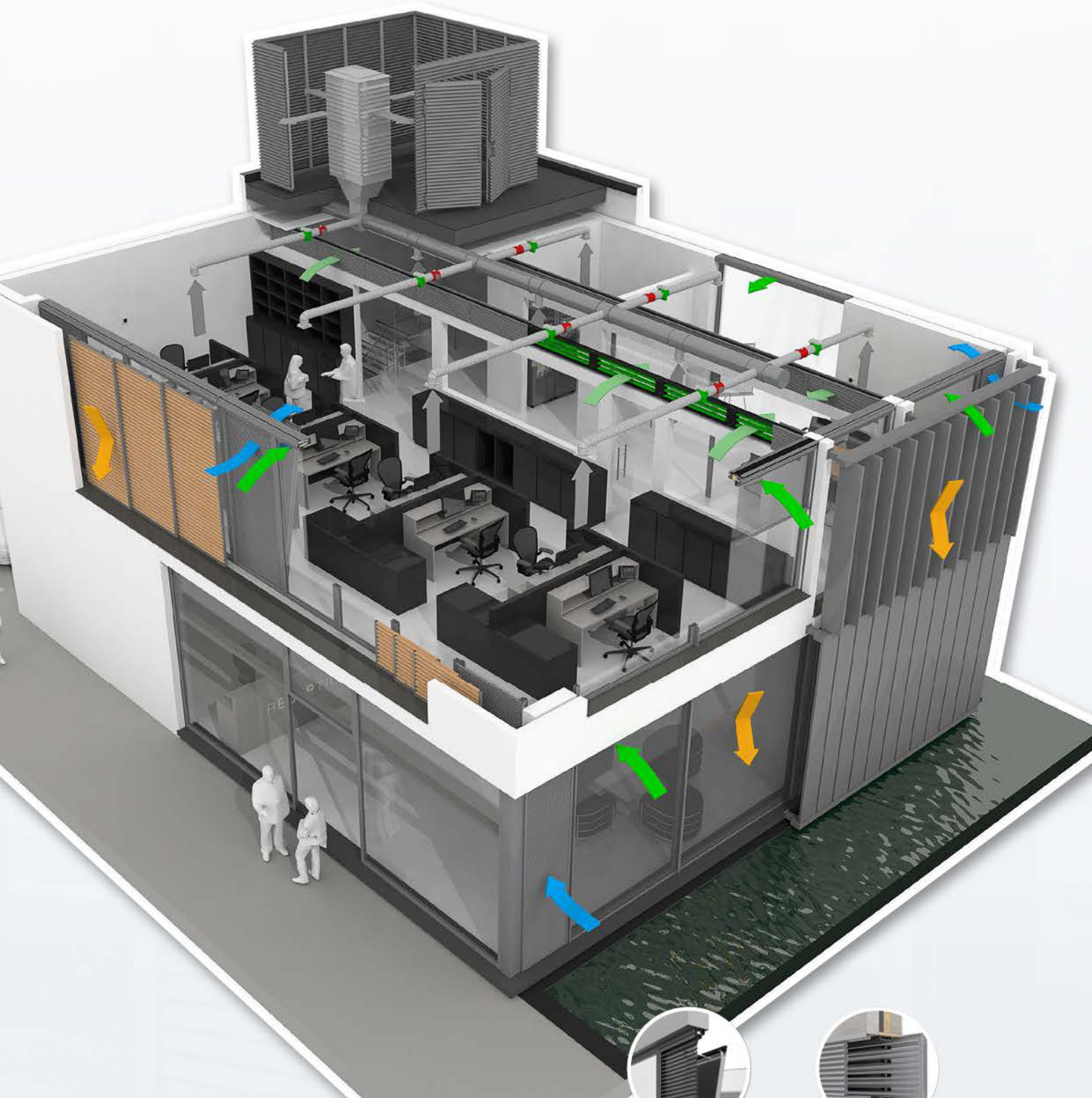

DucoGrille **NightVent**



DucoGrille **Close 105**

DUCO'S SOLUTIONS

DUCO's extensive range of (controlled) wall and window louvres, louvre walls and exterior solar shading are excellent aids within the overall ventilative cooling strategy. Contact your DUCO adviser for more information. We will gladly provide you with tailored advice!

IMPACT AND FALL-THROUGH PROTECTION

Façade elements are increasingly expected to meet 'impact protection' and 'fall-through protection' requirements:



Impact protection

The resistance of a material to which an intense force or shock is exerted for a short period of time.



Fall-through protection

The load applied to resist penetration that prevents people from falling through this barrier.

Note: often a specific mounting method applies or the test is only valid for specific versions (e.g. a certain step, a certain maximum span ...).

Contact DUCO for more information. Full test reports can be requested from DUCO.

Overview of results

DUCO products achieve very good results in terms of impact and fall-through protection:

	Impact protection		Fall-through protection			
	EN 13049	NF P08-302	B03-004	NEN EN1991-1-1	NF P01-013	BS6180
Maximum class	Class 5	H2	Class C5	Class C5	C1-C5/D	XI

DUCOGRILLE SOLID

DucoGrille Solid G 30Z	-	-	-	-	-	X
DucoGrille Solid G 30Z Large	-	-	-	-	-	XI
DucoGrille Solid F 30Z/24	-	-	-	-	-	XI
DucoGrille Solid F 30Z/28	-	-	-	-	-	XI
DucoGrille Solid F 30Z/32	-	-	-	-	-	XI
DucoGrille Solid M 30Z	-	-	-	-	-	XI
DucoGrille Solid++ G 30Z	Class 5	H2/C2	C4	A/B/F/G	A/B*	XI
DucoGrille Solid++ M 30Z	-	-	-	-	-	XI
DucoGrille Solid G 30Z Barrier Load	Class 5	H2/C2	C4	A/B/F/G	A/B*	XI

DUCO BARRIER LOAD LOUVRE

Duco Barrier Load Louvre	Class 5	Louvre blade angle 3°: Q4 Louvre blade angle 45° and 55°: H2	A/B/C4/D	A/B/C4/D	-	XI
---------------------------------	---------	---	----------	----------	---	----

DUCOGRILLE ACOUSTIC

Duco Acoustic Panel 150	Class 5	Q4	C5b	C5	C1-C5/D	XI
Duco Acoustic Panel 300	Class 5	Q4	C5b	C5	C1-C5/D	XI

* Width < 600 mm

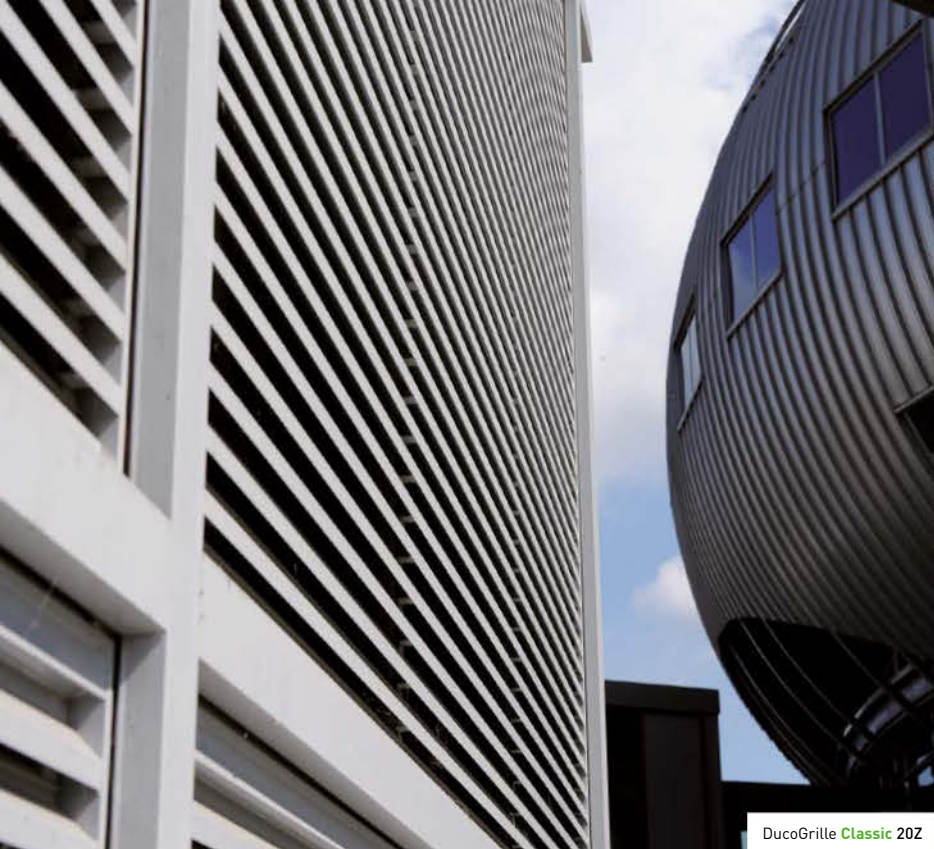

DucoGrille **Classic** 20Z



DucoGrille **Solid** 30Z

DucoGrille **Classic** 50Z



DucoGrille **NightVent**



DucoGrille **NightVent**

DucoGrille **Classic** 20Z

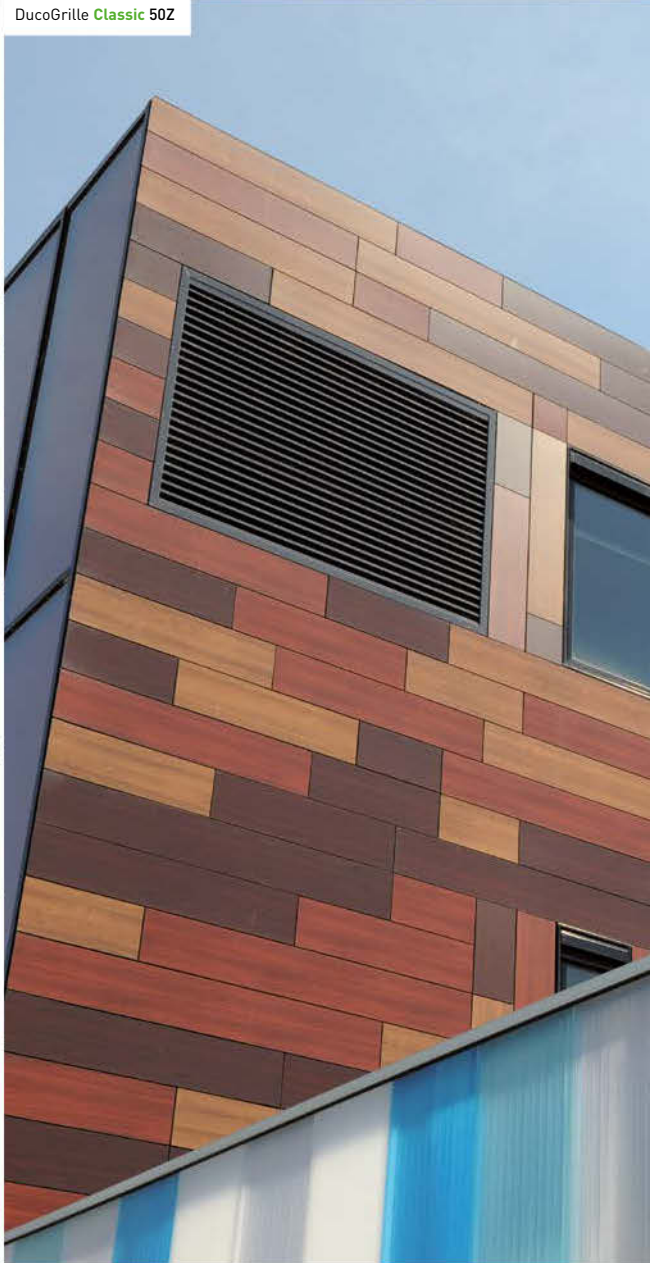

DucoGrille **Classic** 20Z



DucoGrille **Classic** 20Z





DucoGrille **Solid 30Z**



DucoGrille **Classic 20Z**



DucoGrille **Solid MR 30Z**



DucoGrille **Solid++ 30Z**

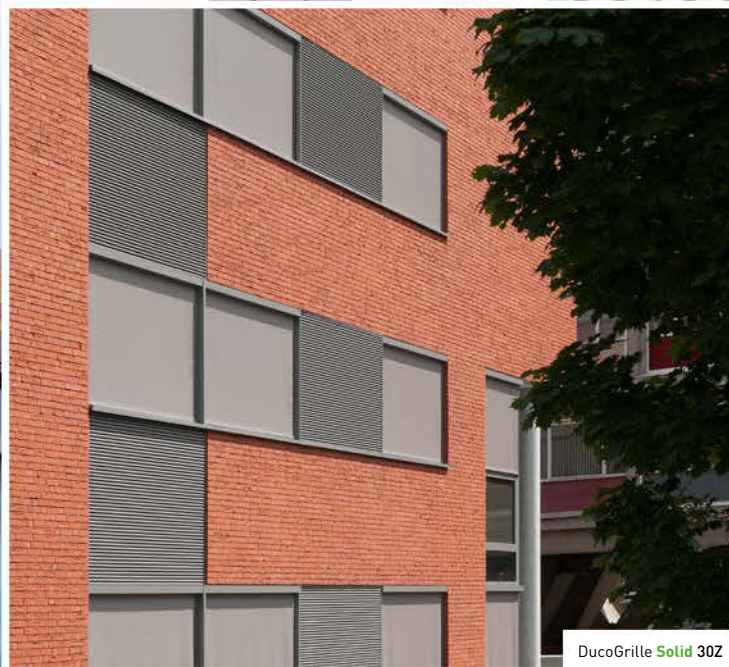

DucoGrille **Solid 30Z**



DucoGrille **NightVent**



DucoGrille **NightVent**



SERVICE PLEASE!

To provide the best support for your project, you will find **sectional drawings, technical data sheets, specification texts** and **assembly instructions** on our **website: www.duco.eu**.

Find out what else DUCO can do for you.



Calculating air flow → airflowcalculation.duco.eu

Calculate the required air flow rates, area or pressure differences for each type of louvre grille with this handy online tool.

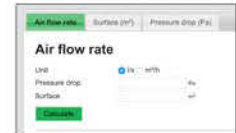

BIM library → www.duco.eu/bim

All products in this library are freely available in Autodesk Revit.

Specification texts → You will find specification texts for all products on our website www.duco.eu.









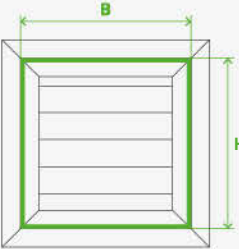

TAILORED **ADVICE**

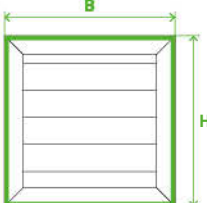
DUCO offers tailored expertise & services for specifiers, and has a dedicated unit to advise and support architects, engineering offices and consultancies. DUCO works with reputable organisations such as the WTCB, the Von Karman Institute, etc. DUCO's knowledge and years of experience enable an appropriate solution to be offered for each of your projects.

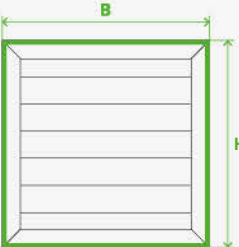
Any questions? Please contact us at info@duco.eu or call 0333 112 1134 for tailored advice!

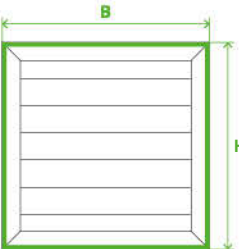
DIMENSIONS AND ORDERING INFORMATION

Grille type	Grille size = ORDER SIZE	Mounting
 <p>G Recessed wall louvres with flange</p>	 <p>Dimension of louvre without flange (installation dimension) = (Width – 10 mm) × (Height – 10 mm) of the wall opening</p>	<p>Fixing lugs supplied as standard. Allow 5 mm clearance (all round) between opening in wall and frame for fixing.</p>
 <p>N Recessed wall louvre without flange</p>	 <p>Dimension of grille (installation dimension) = (Width – 10 mm) × (Height – 10 mm) of the wall opening</p>	
 <p>M Surface mounted wall louvres</p>	 <p>Total Width × total Height of the louvre grille (overall dimension) (MR: diameter of the grille)</p>	<p>Screws and plugs included as standard</p>
 <p>F Window louvres + DucoGrille NightVent</p>	 <p>Total Width × total Height of the louvre grille (overall dimension)</p>	<p>Recessed mounting in window section</p>
 <p>DucoGrille Close 105</p>	<p>Total Width x total Height of the louvre grille (overall dimension)</p>	<p>To be provided by customer</p>
 <p>DucoGrille Transfer</p>	<p>Dimension of grille without flange (installation dimension) = (Width – 10 mm) × (Height – 10 mm) of the wall/door opening</p>	<p>To be provided by customer</p>

TECHNICAL SPECIFICATION TABLE

DUCOGRILLE SOLID

Solid 30Z (Barrier Load)

see p. 8 & p. 12

Solid++ 30Z

see p. 10

Solid ISO 30Z

see p. 11

Classic 20Z

see p. 14

Classic 20V

see p. 15

→ Ventilation values

Feature	Unit	P1		P2		NP	P1		P1	P2	Classic 20Z		Classic 20V	
		STND	+OPT	STND	+OPT	STND	STND	+OPT	STND	STND	STND	+OPT	STND	+OPT
Visual free area	%	60	60	86	86	0	60	60	60	86	63	63	95	95
Physical free area	%	34	34	48	48	0	34	34	34	48	41	41	34	34
K factor, intake (lower is better)		16,94	21,43	15,02	18,58	n/a	16,94	21,43	16,94	15,02	24,27	24,27	41,62	45,04
K factor, exhaust (lower is better)		18,26	17,08	15,62	14,13	n/a	18,26	17,08	18,26	15,62	33,03	33,03	41,62	45,04
Ce (higher is better)		0,243	0,216	0,258	0,232	n/a	0,243	0,216	0,243	0,258	0,203	0,203	0,155	0,149
CD (higher is better)		0,234	0,242	0,253	0,266	n/a	0,234	0,242	0,234	0,253	0,174	0,174	0,155	0,149

→ Water resistance (with insect screen)

Feature	Unit	P1		P2		NP	P1		P1	P2	Classic 20Z		Classic 20V	
		STND	+OPT	STND	+OPT	STND	STND	+OPT	STND	STND	STND	+OPT	STND	+OPT
Water resistance for v = 0 m/s	class	B	B	C	B	n/a	B	B	B	C	C	B	A	A
Water resistance for v = 0.5 m/s	class	C	B	C	B	n/a	C	B	C	C	C	B	B	A
Water resistance for v = 1.0 m/s	class	C	C	C	B	n/a	C	C	C	C	C	C	C	B
Water resistance for v = 1.5 m/s	class	D	C	D	B	n/a	D	C	D	D	D	D	D	B
Water resistance for v = 2.0 m/s	class	D	D	D	C	n/a	D	D	D	D	D	D	D	C
Water resistance for v = 2.5 m/s	class	D	D	D	D	n/a	D	D	D	D	D	D	D	D

→ Sound reduction

Solution		P1	P2	NP	P1	P1	P2	Classic 20Z		Classic 20V	
Rw	dB	n/a	n/a	n/a	n/a	n/a	n/a	n/a	n/a	n/a	n/a
C		n/a	n/a	n/a	n/a	n/a	n/a	n/a	n/a	n/a	n/a
C _{tr}		n/a	n/a	n/a	n/a	n/a	n/a	n/a	n/a	n/a	n/a
Octave band values	at 125 Hz	dB	n/a	n/a	n/a	n/a	n/a	n/a	n/a	n/a	n/a
	at 250 Hz	dB	n/a	n/a	n/a	n/a	n/a	n/a	n/a	n/a	n/a
	at 500 Hz	dB	n/a	n/a	n/a	n/a	n/a	n/a	n/a	n/a	n/a
	at 1000 Hz	dB	n/a	n/a	n/a	n/a	n/a	n/a	n/a	n/a	n/a
	at 2000 Hz	dB	n/a	n/a	n/a	n/a	n/a	n/a	n/a	n/a	n/a
	at 4000 Hz	dB	n/a	n/a	n/a	n/a	n/a	n/a	n/a	n/a	n/a

→ Frame types and dimensions

Feature		Unit	P1	P2	NP	P1	P1	P2	Classic 20Z		Classic 20V	
Louvre pitch		mm	37,5			37,5	37,5		35	20		
G Recessed wall louvre with flange	Installation depth	mm	G: 34 / G Large: 32 / Barrier Load: 38			38,4	x		30	30		
	Frame rebate	mm	G: 18 / G Large: 40 / Barrier Load: 15			15	x		19	19		
N Recessed wall louvre without flange	Installation depth	mm	x			x	x		x	x		
	Frame rebate	mm	x			x	x		x	x		
F Window louvre	Flange width	mm	24/28/32			x	24/28/32/36/40/44/48		24	24		
	Frame depth	mm	38 (F30Z/24) 42 (F30Z/28 en F30Z/32)			x	88		35	35		
M Surface mounted wall louvre	Installation depth	mm	Rectangular (M): 43 Round (MR): 35 *no +OPT version possible with M grille			42 *no +OPT version possible with M grille	x		x	x		
Minimum / maximum louvre dimensions (Width x Height)		mm	Rectangular (G, F, M): min. W 200 x H 200 Round (MR): min. dia. 300 - max. dia. 1500			min. W 200 x H 200	min. 300 x 300 mm max. 2500 mm high / wide if other dimension < 1250 mm		min. W 200 x H 200	min. W 200 x H 200		

DUCOGRILLE CLASSIC

Classic 50Z see p. 16	Classic 50/75Z see p. 17	Classic 45HP see p. 18	Classic 50HP see p. 19	Classic 60HP see p. 20	Classic 60HP Vertical see p. 21	Classic 130HP see p. 22	Classic 130HP Basic see p. 23	Classic 70V see p. 24	Classic 70V Vertical see p. 25
---	--	--	--	--	---	---	---	---	--

STND	+OPT	STND	+OPT	STND	+OPT	STND	+OPT	STND	+OPT	STND	+OPT	STND	STND	STND	+OPT	STND	+OPT
75	75	80	80	70	70	88	88	60	60	60	n/a	88	88	65	65	65	65
47	47	49	49	60	60	68	68	50	50	50	n/a	70	70	36	36	36	36
18,58	23,34	17,51	20,85	8,60	11,49	6,28	8,07	25,00	25,77	26,85	n/a	9,02	9,70	73,05	81,16	73,05	81,16
14,46	14,13	12,94	12,06	7,51	7,34	6,51	5,81	15,75	15,62	16,94	n/a	12,40	13,13	84,17	94,26	84,17	94,26
0,232	0,207	0,239	0,219	0,341	0,295	0,399	0,352	0,200	0,197	0,193	n/a	0,333	0,321	0,117	0,111	0,117	0,111
0,263	0,266	0,278	0,288	0,365	0,369	0,392	0,415	0,252	0,253	0,243	n/a	0,284	0,276	0,109	0,103	0,109	0,103

STND	+OPT	STND	+OPT	STND	+OPT	STND	+OPT	STND	+OPT	STND	+OPT	STND	STND	STND	+OPT	STND	+OPT
C	A	C	A	C	B	C	B	A	A	A	n/a	A	A	B	A	A	A
C	B	C	B	C	B	C	B	A	A	A	n/a	A	A	B	B	A	A
C	B	C	B	D	C	C	B	A	A	A	n/a	A	A	B	B	A	A
D	C	D	C	D	C	D	C	A	A	A	n/a	A	B	C	C	C	A
D	C	D	C	D	C	D	C	A	A	A	n/a	A	B	D	D	C	A
D	D	D	D	D	C	D	C	C	A	A	n/a	A	C	D	D	D	C

n/a	n/a	n/a	n/a	n/a	n/a	n/a	n/a	n/a	n/a	n/a	n/a	n/a	n/a	n/a	n/a	n/a	n/a
n/a	n/a	n/a	n/a	n/a	n/a	n/a	n/a	n/a	n/a	n/a	n/a	n/a	n/a	n/a	n/a	n/a	n/a
n/a	n/a	n/a	n/a	n/a	n/a	n/a	n/a	n/a	n/a	n/a	n/a	n/a	n/a	n/a	n/a	n/a	n/a
n/a	n/a	n/a	n/a	n/a	n/a	n/a	n/a	n/a	n/a	n/a	n/a	n/a	n/a	n/a	n/a	n/a	n/a
n/a	n/a	n/a	n/a	n/a	n/a	n/a	n/a	n/a	n/a	n/a	n/a	n/a	n/a	n/a	n/a	n/a	n/a
n/a	n/a	n/a	n/a	n/a	n/a	n/a	n/a	n/a	n/a	n/a	n/a	n/a	n/a	n/a	n/a	n/a	n/a
n/a	n/a	n/a	n/a	n/a	n/a	n/a	n/a	n/a	n/a	n/a	n/a	n/a	n/a	n/a	n/a	n/a	n/a
n/a	n/a	n/a	n/a	n/a	n/a	n/a	n/a	n/a	n/a	n/a	n/a	n/a	n/a	n/a	n/a	n/a	n/a

65	75	50	50	25	25	50	50	65	65								
62	62	62	62	76,5	76,5	158	158	82	82								
48	48	48	48	33	33	48	48	48	48								
65	65	65	65	76,5	76,5	158	158										
0	0	0	0	0	0	0	0										
28	28	28	28	28 - 32	28 - 32												
77	77	77	77	76,5	76,5												
x	x	x	x	x	x	x	x	x	x	x	x	x	x	x	x	x	x

Type G & N: min. W 300 x H 300	Type G & N: min. W 300 x H 300	min. W 250 x H 250	min. W 250 x H 250	Type G & N: min. W 200 x H 200	Type G & N: min. W 200 x H 200	min. W 250 x H 250	min. W 250 x H 250	min. W 300 x H 300	min. W 300 x H 300
Type F: min. W 300 x H 350	Type F: min. W 300 x H 350			Type F: min. W 300 x H 300	Type F: min. W 300 x H 300				

TECHNICAL SPECIFICATION TABLE

DUCOGRILLE ACOUSTIC

Acoustic 75Z

see p. 28

Acoustic 75L

see p. 28

Acoustic 150

see p. 29

Acoustic Panel

see p. 30

→ Ventilation values

Feature	Unit	75Z		75L		150		300	
		STND	+OPT	STND	+OPT	STND	+OPT	STND	+OPT
Visual free area	%	76	76	95	95	74	71	71	71
Physical free area	%	28	28	28	28	35	31	31	31
K factor, intake (lower is better)		16,94	26,03	16,52	22,89	11,49	15,87	17,95	26,57
K factor, exhaust (lower is better)		21,84	30,19	12,14	15,50	11,41	16,26	16,26	27,41
Ce (higher is better)		0,243	0,196	0,246	0,209	0,295	0,251	0,236	0,194
CD (higher is better)		0,214	0,182	0,287	0,254	0,296	0,248	0,248	0,191

→ Water resistance (with insect screen)

Feature	Unit	75Z		75L		150		300	
		STND	+OPT	STND	+OPT	STND	+OPT	STND	+OPT
Water resistance for v = 0 m/s	class	B	B	B	B	B	C	B	C
Water resistance for v = 0.5 m/s	class	B	B	C	B	C	D	C	D
Water resistance for v = 1.0 m/s	class	C	C	C	C	C	D	D	D
Water resistance for v = 1.5 m/s	class	D	C	D	D	C	D	D	D
Water resistance for v = 2.0 m/s	class	D	D	D	D	D	D	D	D
Water resistance for v = 2.5 m/s	class	D	D	D	D	D	D	D	D

→ Sound reduction

Solution		Unit	75Z	75L	150	300
Rw		dB	6	6	11	17
C			0	0	-1	-1
C _{tr}			-1	-2	-2	-4
Octave band values	at 125 Hz	dB	2,7	2,6	4,8	6,3
	at 250 Hz	dB	3,5	3	4	5,9
	at 500 Hz	dB	2,1	1,9	7,4	11,6
	at 1000 Hz	dB	4,8	4,4	11,4	20,1
	at 2000 Hz	dB	10,1	9,7	12,4	22,7
	at 4000 Hz	dB	12,4	11,5	13	21,5

→ Frame types and dimensions

Feature		Unit	75Z	75L	150	300
Louvre pitch		mm	60	60	150	130
G Recessed wall louvre with flange	Installation depth	mm	82	82	158	303
	Frame rebate	mm	48	48	48	37
N Recessed wall louvre without flange	Installation depth	mm	×	×	158	×
	Frame rebate	mm	×	×	0	×
F Window louvre	Flange width	mm	×	×	×	×
	Frame depth	mm	×	×	×	×
M Surface mounted wall louvre	Installation depth	mm	×	×	×	×
Minimum / maximum louvre dimensions (Width x Height)		mm	min. W 250 x H 250	min. W 250 x H 250	min. W 250 x H 250	min. W 250 x H 280

DUCOGRILLE TRANSFER		DUCOGRILLE CLOSE			DUCOGRILLE NIGHTVENT
Transfer	Transfer Acoustic	Close 105	Close 35Z	Close M 100	NightVent
see p. 32	see p. 33	see p. 34	see p. 36	see p. 37	see p. 38
STND	STND	STND	STND	STND	STND
95	27	74*	51	28	60
34	18	74*	39	28	34
41,62	145,16	2,57*	30,19	89,00	24,51
41,62	148,72	2,57*	23,56	89,00	24,51
0,155	0,083	0,624*	0,182	0,106	0,202
0,155	0,082	0,624*	0,206	0,106	0,202
		* measured without internal and external louvre grille			
STND	STND	STND	STND	STND	STND
A	A	n/a	B	n/a	A
B	A	n/a	B	n/a	B
C	C	n/a	C	n/a	C
D	D	n/a	D	n/a	D
D	D	n/a	D	n/a	D
D	D	n/a	D	n/a	D
					Closed
n/a	see p. 33	21	n/a	n/a	33
n/a		-2	n/a	n/a	-1
n/a		-2	n/a	n/a	-4
n/a		13,7	n/a	n/a	21,5
n/a		14,6	n/a	n/a	21,3
n/a		16,5	n/a	n/a	28,2
n/a		20,9	n/a	n/a	37,1
n/a		23,2	n/a	n/a	45,2
n/a	29,8	n/a	n/a	53,7	
20	35	91	50	n/a	37,5
28 - 84	28 - 84	see p. 34	45	×	×
21	21		20	×	×
×	×		45	×	×
×	×		0	×	×
×	×		24/28	×	24/28/32/36/40/44/48
×	×	45	×	115	
×	×		×	13	×
Without counterframe: min. W 190 x H 90 mm	Without counterframe: min. W 245 x H 115 mm	see drawing on p. 35	see table on p. 36	fixed height 200 or 300 max. width 1000 mm	see tables on p. 40
With counterframe: min. W 200 x H 100 mm	With counter-frame: min. W 255 x H 125 mm				



A **SOLUTION**
FOR EVERY
PROJECT

DUCO