

Type	<b>Duco Barrier Load Louvre - Luxframe 35/70 - 55°</b>		
<b>BESCHRIJVING</b>	Vast paneel als valbeveiliging		
<b>VORM LAMEL</b>	60F Barrier Load		
<b>LAMEL HELLING</b>	55°		
<b>LAMELSTAP</b>	Volgens specificatie berekening valbeveiliging, maximum stap = 100 mm		
<b>KADERBREEDTE</b>	35 mm		
<b>OPBOUW DIEPTE</b>	70 mm		
<b>MIN. AFMETING</b>	- Breedte 100 mm		
<b>MAX. AFMETING</b>	- Breedte 1000 mm		
<b>BRANDREACTIE</b>	A2-s1,d0 (EN13501-1)		
<b>MATERIAAL</b>	Aluminium : EN AW-6063 T66 (EN 573-3) Profiel dikte : min. 1,5mm		
<b>OPPERVLAKTE BEHANDELING</b>	- gemoffeld polyester poedercoating (60-80µm) volgens Qualicoat Seaside type A - specifieke RAL codes en/of structuurlak op aanvraag		
<b>IMPACT BEVEILIGING</b>		Gemonteerd op raamprofiel (kozijn)	Vast gemonteerd op vier hoeken
	EN13049	Klasse 5	Pending
	NF P08-302	Klasse H2	Pending
<b>DOORVALBEVEILIGING</b>	B03-004	Klasse A/B/C4/D	Pending
	NEN-EN1991-1-1	Klasse A/B/C4/D	Pending
	BS6180	Klasse XI*	Pending

\* Controleer het berekeningsprogramma voor maximale stap en breedte

3

2

1

D

D

C

C

B

B

A

A

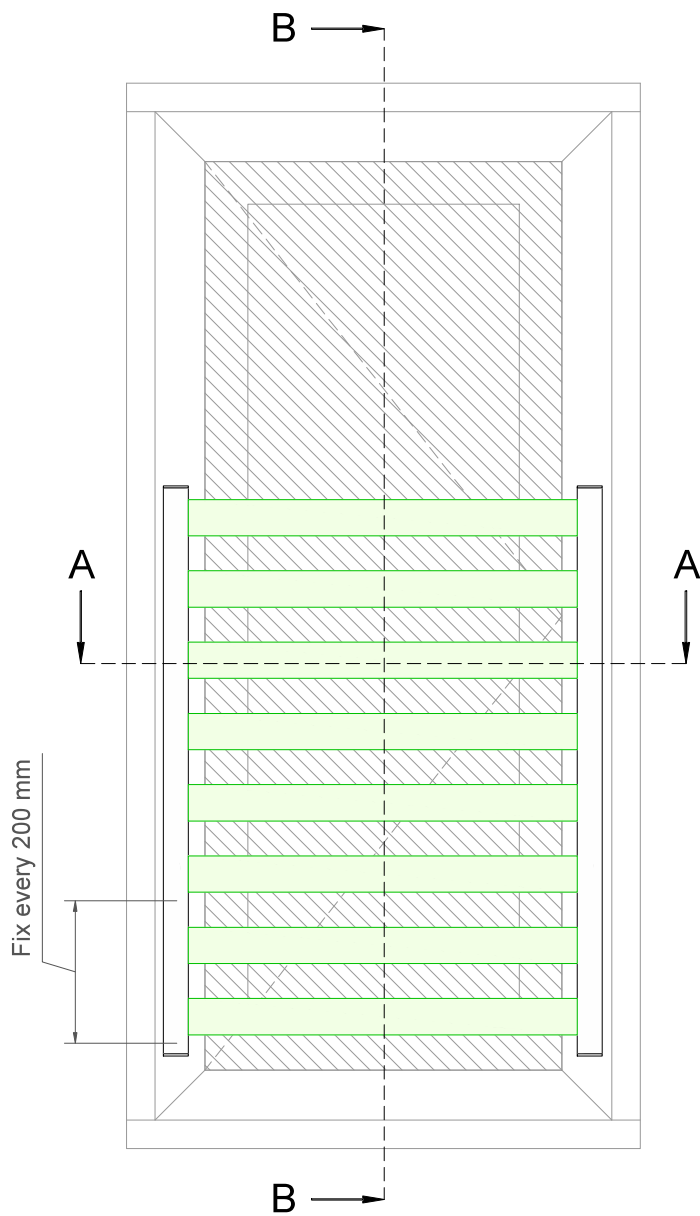

Section B-B

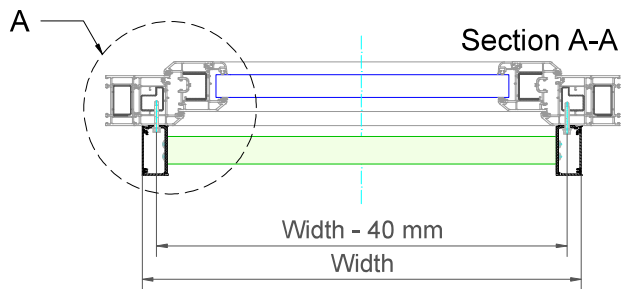
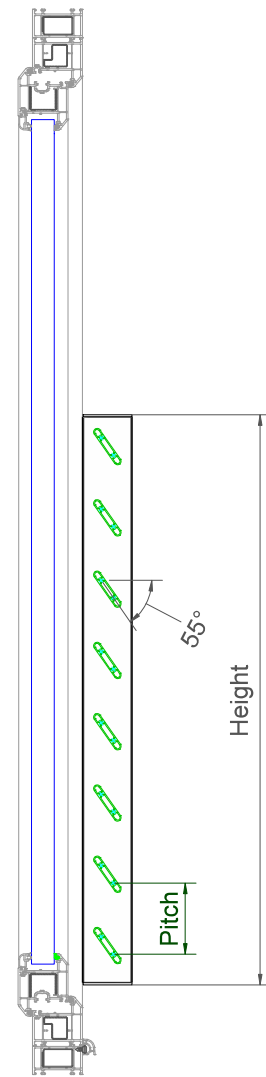

Section A-A

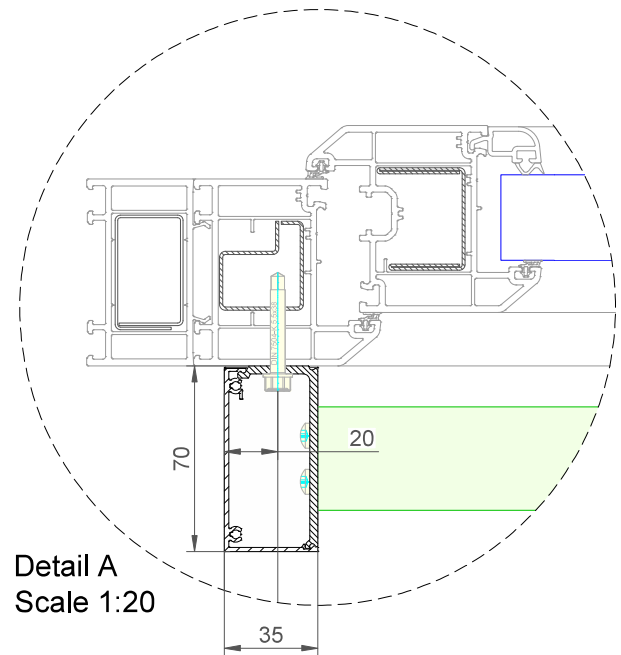
Detail A  
Scale 1:20**example only - not for construction use**

Duco Barrier Load Louvre - Luxframe 35-70 - 55°

Datum : 27/05/2024

Schaal : 1:7,5

Window profiles for example purposes only.  
Check compatibility with window manufacturer

**DUCO**  
Ventilation & Sun Control

Tol. : ISO 2768-mK

Getekend : RTN

Mat. : Aluminium

Ref nr. :

Formaat : A3



Tekening nr. :

In case of PVC windows: screw fixations  
should always be anchored in the steel  
reinforcement of the frame

Bedrijvenlaan 2, - 8630 VEURNE  
tel. 0032-58/330066 - fax.0032-58/330067  
email: info@duco.eu www.duco.eu  
Deze tekening is eigendom van Duco Projects en mag niet gekopieerd  
noch getoond worden aan derden zonder schriftelijke toestemming

omtrek

gewicht

lakoppervl.

Barrier Load Louvre - Luxframe 35-70 - 55°

mm

kg/m

dm²/m

3

2

1

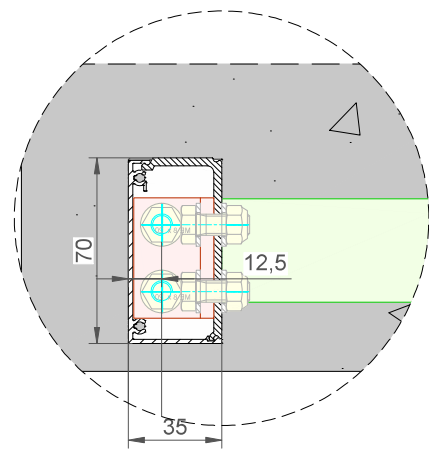
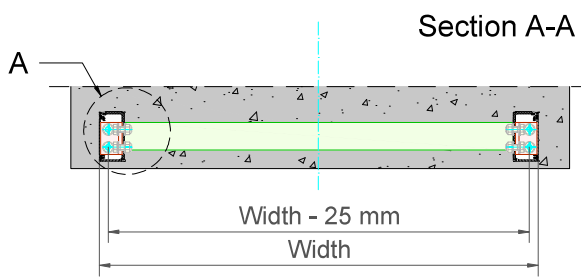
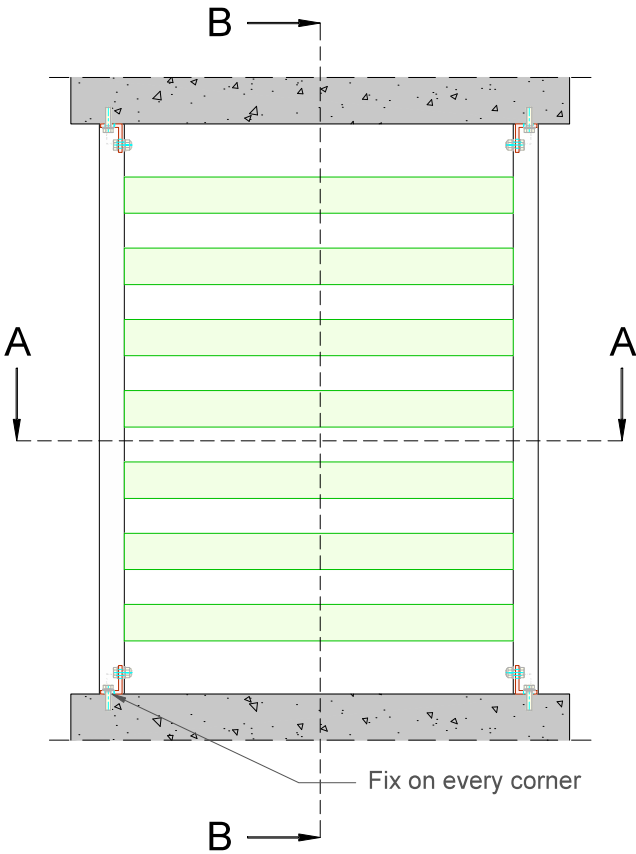

example only - not for construction use	Duco Barrier Load Louvre - Luxframe 35-70 - 55° - In Dag	Datum : 27/05/2024	
		Schaal : 1:7,5	
Window profiles for example purposes only. Check compatibility with window manufacturer	<b>DUCO</b> Ventilation & Sun Control	Tol. : ISO 2768-mK	
		Getekend : RTN	
In case of PVC windows: screw fixations should always be anchored in the steel reinforcement of the frame	Bedrijvenlaan 2, - 8630 VEURNE tel. 0032-58/330066 - fax.0032-58/330067 email: info@duco.eu www.duco.eu Deze tekening is eigendom van Duco Projects en mag niet gekopieerd noch getoond worden aan derden zonder schriftelijke toestemming	Mat. : Aluminium	
		Ref nr. :	
		Formaat : A3	Tekening nr. :
		omtrek      gewicht      lakoppervl.	
		mm      kg/m      dm <sup>2</sup> /m	Barrier Load Louvre - Luxframe 35-70 - 55° ID