

3

2

1

D

D

C

C

B

B

A

A

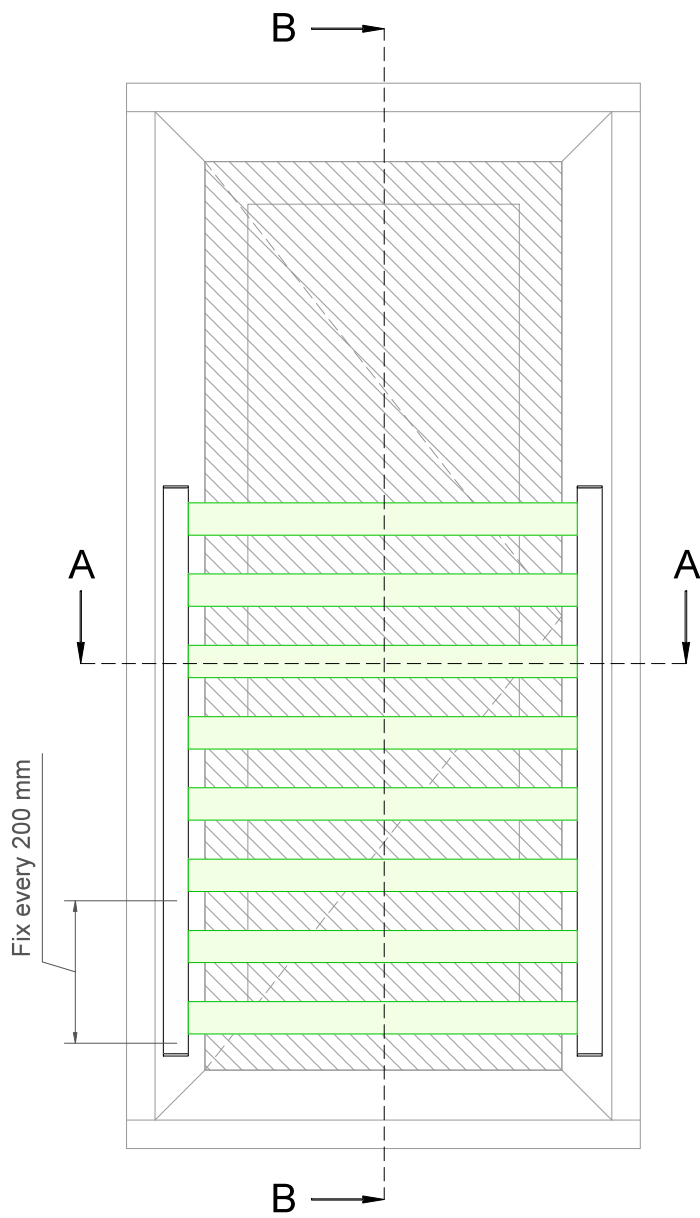

Section B-B

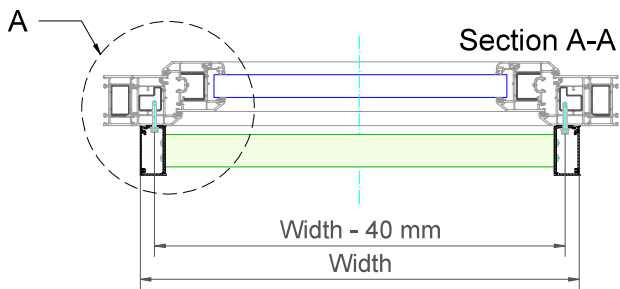
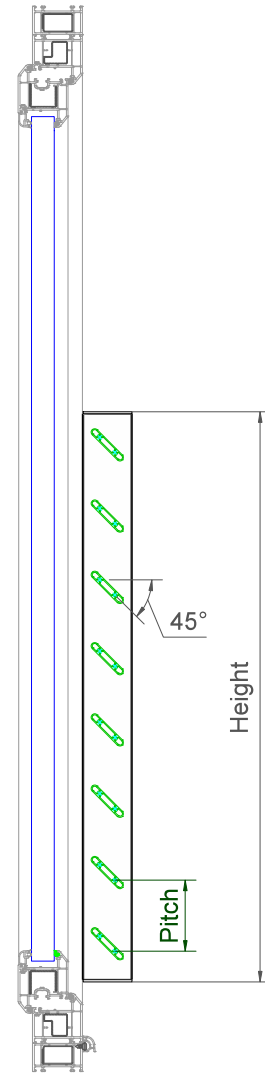

Section A-A

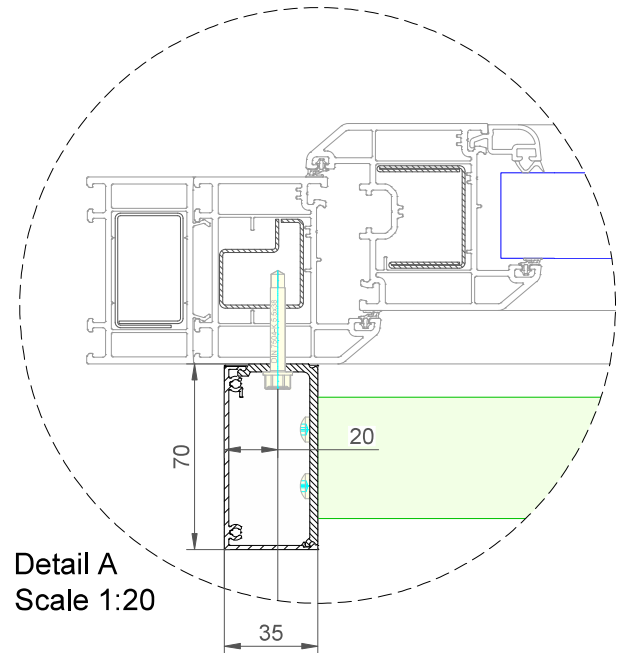
Detail A
Scale 1:20**example only - not for construction use**

Duco Barrier Load Louvre - Luxframe 35-70 - 3°

Datum : 22/04/2024

Schaal : 1:7,5

Window profiles for example purposes only.
Check compatibility with window manufacturer

DUCO
Ventilation & Sun Control

Bedrijvenlaan 2, - 8630 VEURNE
tel. 0032-58/330066 - fax.0032-58/330067
email: info@duco.eu www.duco.eu
Deze tekening is eigendom van Duco Projects en mag niet gekopieerd
noch getoond worden aan derden zonder schriftelijke toestemming

Tol. : ISO 2768-mK

Getekend : RTN

Mat. : Aluminium

Ref nr. :

Formaat : A3



omtrek

gewicht

lakoppervl.

Tekening nr. :

In case of PVC windows: screw fixations
should always be anchored in the steel
reinforcement of the frame

Barrier Load Louvre - Luxframe 35-70 - 3°

3

2

1

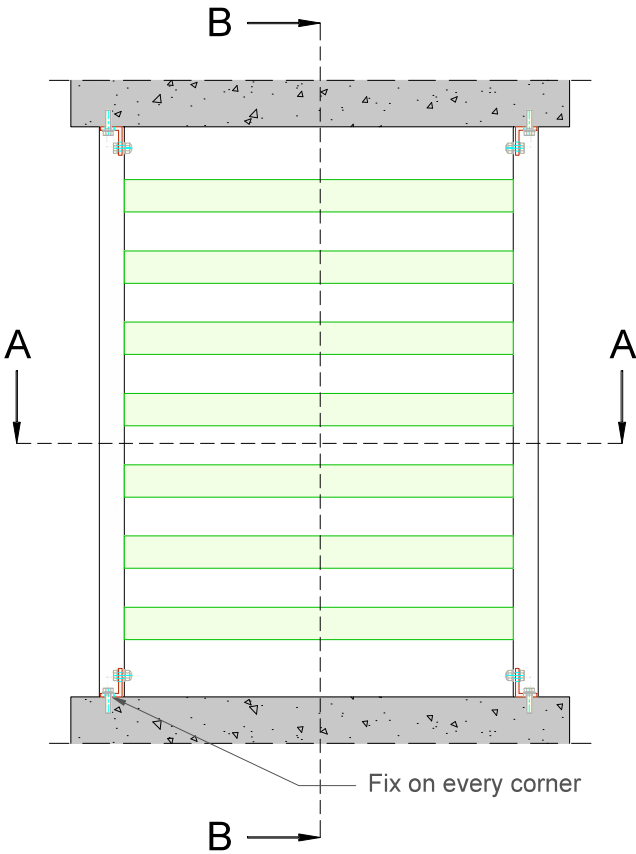

Section B-B

Section A-A

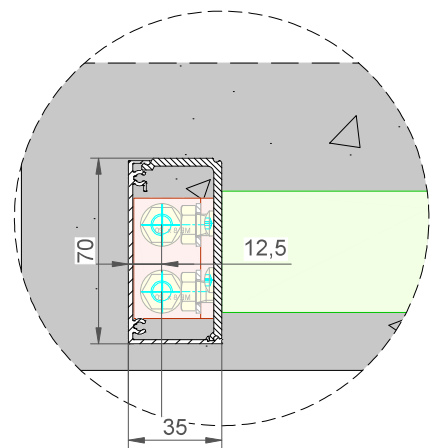
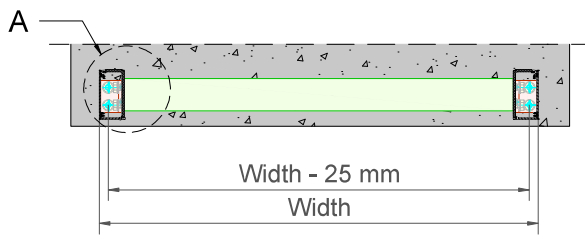

Detail A
Scale 1:20

example only - not for construction use

Duco Barrier Load Louvre - Luxframe 35-70 - 3° - In Dag

Datum : 22/04/2024

Schaal : 1:7,5

Window profiles for example purposes only.
Check compatibility with window manufacturer



Tol. : ISO 2768-mK

Getekend : RTN

Mat. : Aluminium

Ref nr. :

Formaat : A3



Tekening nr. :

In case of PVC windows: screw fixations
should always be anchored in the steel
reinforcement of the frame

Bedrijvenlaan 2, - 8630 VEURNE
tel. 0032-58/330066 - fax.0032-58/330067
email: info@duco.eu www.duco.eu
Deze tekening is eigendom van Duco Projects en mag niet gekopieerd
noch getoond worden aan derden zonder schriftelijke toestemming

omtrek

gewicht

lakoppervl.

Barrier Load Louvre - Luxframe 35-70 - 3° ID

mm

kg/m

dm²/m