

Type	<b>Duco Barrier Load Louvre - Luxframe 35/70 - 3°</b>		
BESCHRIJVING	Vast paneel als valbeveiliging		
VORM LAMEL	60F Barrier Load		
LAMEL HELLING	3°		
LAMELSTAP	Volgens specificatie berekening valbeveiliging, maximum stap = 100 mm		
KADERBREEDTE	35 mm		
OPBOUW DIEPTE	70 mm		
MIN. AFMETING	- Breedte 100 mm		
MAX. AFMETING	- Breedte 1000 mm		
BRANDREACTIE	A2-s1,d0 (EN13501-1)		
MATERIAAL	Aluminium : EN AW-6063 T66 (EN 573-3) Profiel dikte : min. 1,5mm		
OPPERVLAKTE BEHANDELING	- gemoffeld polyester poedercoating (60-80µm) volgens Qualicoat Seaside type A - specifieke RAL codes en/of structuurlak op aanvraag		
IMPACT BEVEILIGING		Gemonteerd op raamprofiel (kozijn)	Vast gemonteerd op vier hoeken
	EN13049	Klasse 5	Pending
DOORVALBEVEILIGING	NF P08-302	Klasse Q4	Pending
	B03-004	Klasse A/B/C4/D	Pending
	NEN-EN1991-1-1	Klasse A/B/C4/D	Pending
	BS6180	Klasse XI*	Pending

\* Controleer het berekeningsprogramma voor maximale stap en breedte

3

2

1

D

D

C

C

B

B

A

A

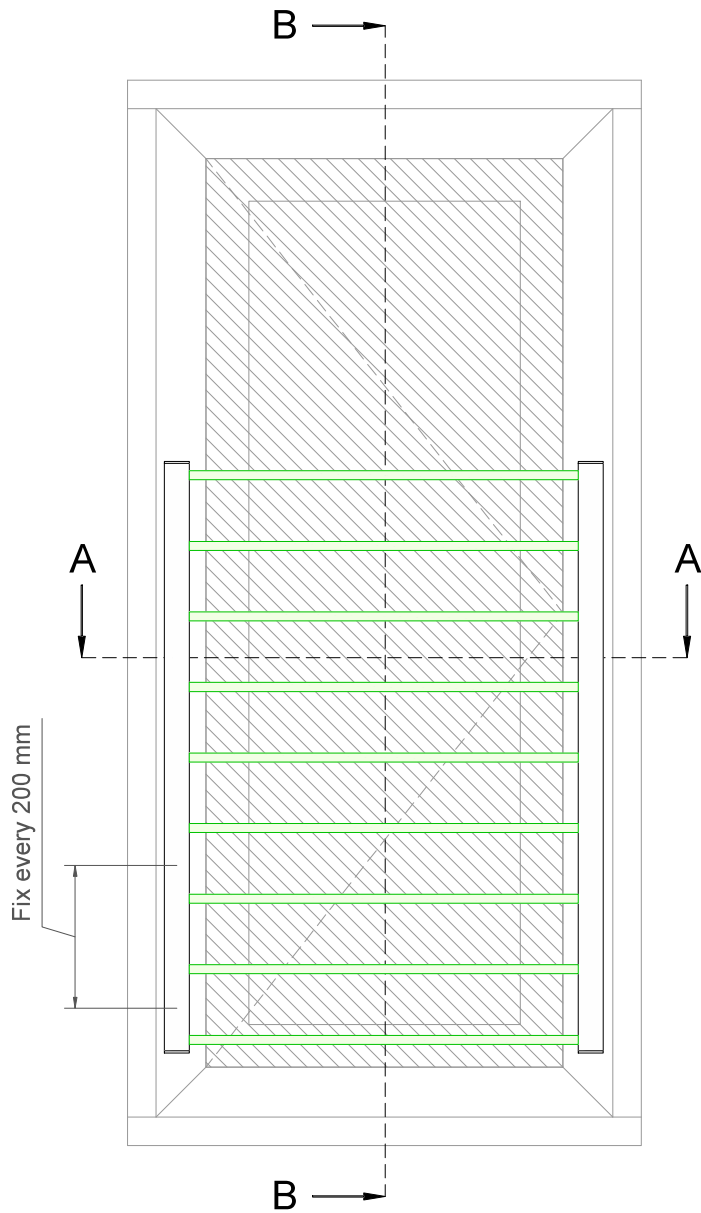

Section B-B

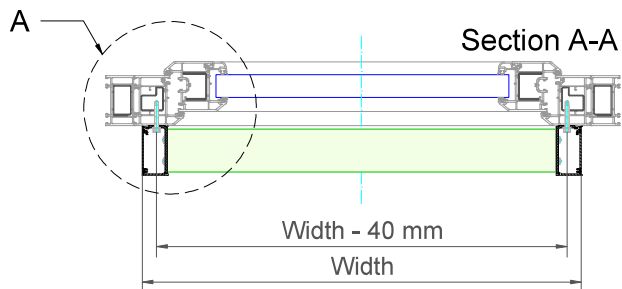
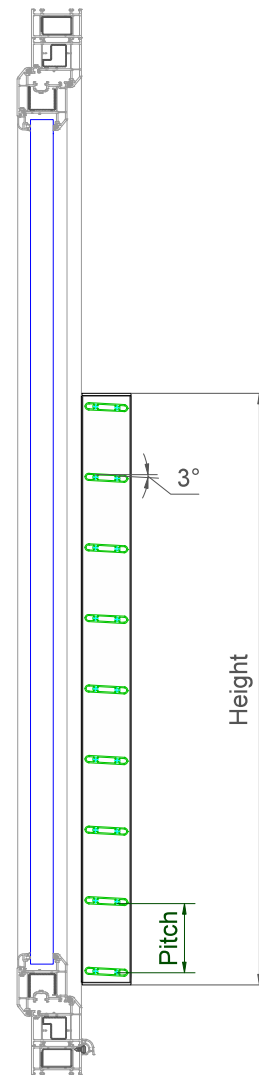

Section A-A

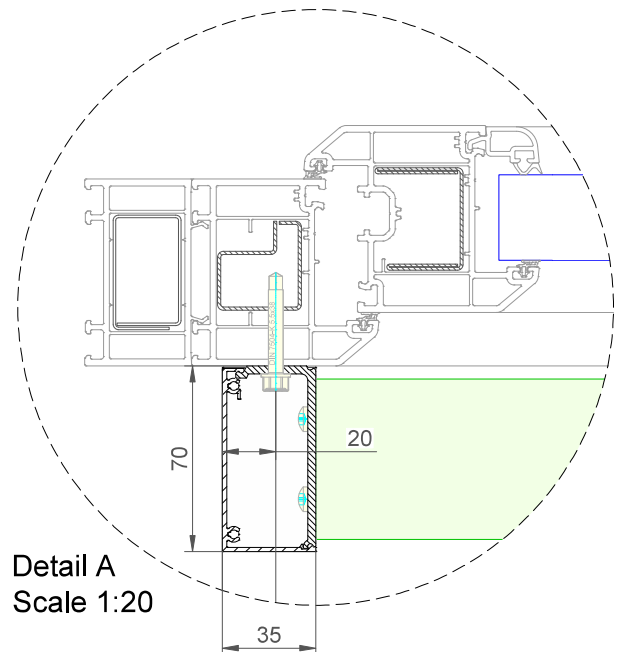
Detail A  
Scale 1:20**example only - not for construction use**

Duco Barrier Load Louvre - Luxframe 35-70 - 3°

Datum : 22/04/2024

Schaal : 1:7,5

Window profiles for example purposes only.  
Check compatibility with window manufacturer

**DUCO**  
Ventilation & Sun Control

Tol. : ISO 2768-mK

Getekend : RTN

Mat. : Aluminium

Ref nr. :

Formaat : A3



Tekening nr. :

In case of PVC windows: screw fixations  
should always be anchored in the steel  
reinforcement of the frame

Bedrijvenlaan 2, - 8630 VEURNE  
tel. 0032-58/330066 - fax.0032-58/330067  
email: info@duco.eu www.duco.eu  
Deze tekening is eigendom van Duco Projects en mag niet gekopieerd  
noch getoond worden aan derden zonder schriftelijke toestemming

omtrek

gewicht

lakoppervl.

Barrier Load Louvre Luxframe 35-70 - 3°

mm

kg/m

dm²/m

3

2

1

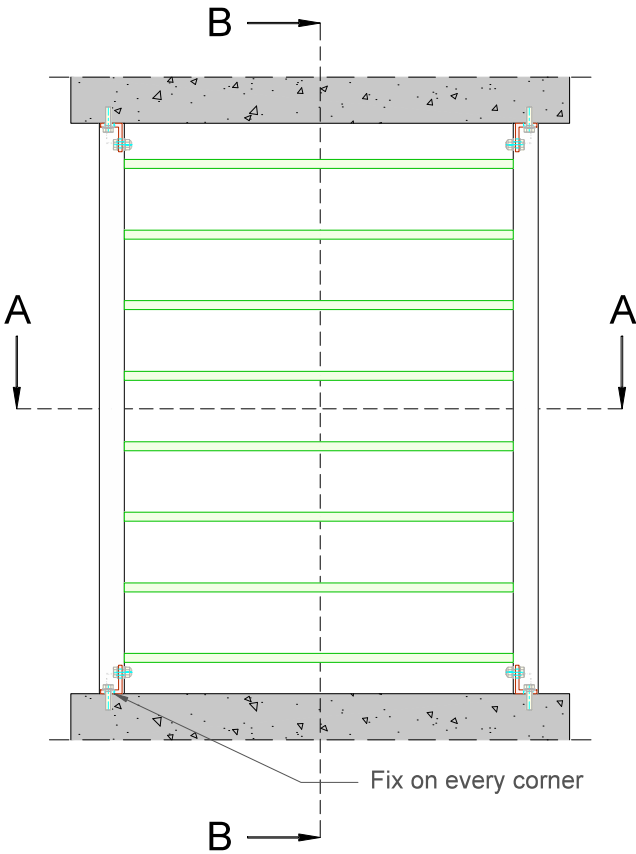

Section B-B

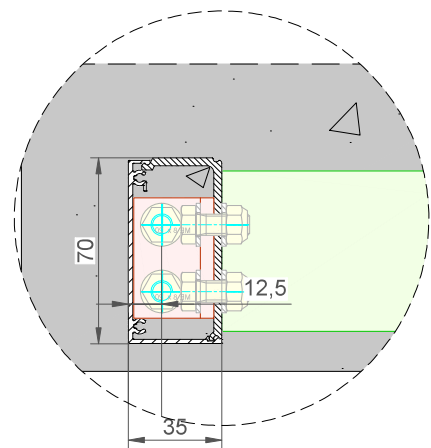
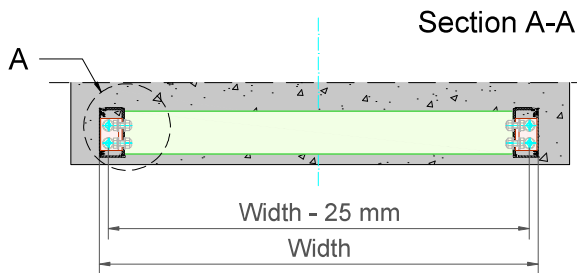
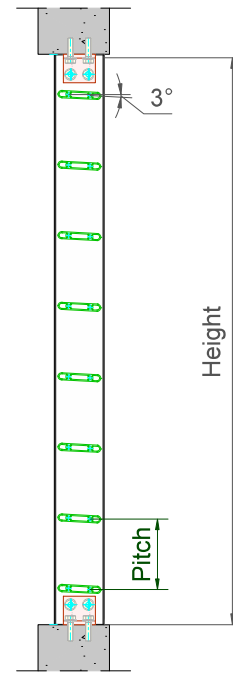

Detail A  
Scale 1:20

example only - not for construction use

Duco Barrier Load Louvre - Luxframe 35-70 - 3° - In dag

Datum : 22/04/2024

Schaal : 1:7,5

Window profiles for example purposes only.  
Check compatibility with window manufacturer



Tol. : ISO 2768-mK

Getekend : RTN

Mat. : Aluminium

Ref nr. :

Formaat : A3



Tekening nr. :

In case of PVC windows: screw fixations  
should always be anchored in the steel  
reinforcement of the frame

Bedrijvenlaan 2, - 8630 VEURNE  
tel. 0032-58/330066 - fax.0032-58/330067  
email: info@duco.eu www.duco.eu  
Deze tekening is eigendom van Duco Projects en mag niet gekopieerd  
noch getoond worden aan derden zonder schriftelijke toestemming

omtrek

gewicht

lakoppervl.

Barrier Load Louvre Luxframe 35-70 - 3° ID

mm

kg/m

dm²/m